



INSTRUCTIONS FOR:

TIG/MMA HF INVERTER WELDER 160Amp 230V

MODEL No: **TIG160HF**



Thank you for purchasing a Sealey Welder. Manufactured to a high standard this product will, if used according to these instructions and properly maintained, give you years of trouble free performance.



IMPORTANT: BEFORE USING THIS PRODUCT, PLEASE READ THE INSTRUCTIONS CAREFULLY. MAKE CAREFUL NOTE OF SAFETY INSTRUCTIONS, WARNINGS AND CAUTIONS. THIS PRODUCT SHOULD ONLY BE USED FOR ITS INTENDED PURPOSE. FAILURE TO DO SO MAY CAUSE DAMAGE OR PERSONAL INJURY, AND WILL INVALIDATE THE WARRANTY. RETAIN THESE INSTRUCTIONS FOR FUTURE USE.

1. SAFETY INSTRUCTIONS

1.1 ELECTRICAL SAFETY

WARNING! It is the user's responsibility to read, understand and comply with the following:

You must check all electrical equipment and appliances to ensure they are safe before using. You must inspect power supply leads, plugs and all electrical connections for wear and damage. You must ensure the risk of electric shock is minimised by the installation of appropriate safety devices. An RCCB (Residual Current Circuit Breaker) should be incorporated in the main distribution board. We also recommend that an RCD (Residual Current Device) is used with all electrical products. It is particularly important to use an RCD together with portable products that are plugged into an electrical supply not protected by an RCCB. If in doubt consult a qualified electrician. You may obtain a Residual Current Device by contacting your Sealey dealer. **You must** also read and understand the following instructions concerning electrical safety.

- 1.1.1 The Electricity At Work Act 1989 requires all portable electrical appliances, if used on business premises, to be tested by a qualified electrician, using a Portable Appliance Tester (PAT), at least once a year.
- 1.1.2 The **Health & Safety at Work Act 1974** makes owners of electrical appliances responsible for the safe condition of the appliance, and the safety of the appliance operator. **If in any doubt about electrical safety, contact a qualified electrician.**
- 1.1.3 Ensure the insulation on all cables and the product itself is safe before connecting to the mains power supply. See 1.1.1. & 1.1.2. above and use a Portable Appliance Tester (PAT).
- 1.1.4 Ensure that cables are always protected against short circuit and overload.
- 1.1.5 Regularly inspect power supply leads, plugs and all electrical connections for wear and damage and especially power connections, to ensure that none is loose.
- 1.1.6 **Important:** Ensure the voltage marked on the product is the same as the electrical power supply to be used and check that plugs are fitted with the correct capacity fuse. A 13Amp plug may require a fuse smaller than 13Amps for certain products, see fuse rating at right.
- 1.1.7 **DO NOT** pull or carry the powered appliance by its power supply lead.
- 1.1.8 **DO NOT** pull power plugs from sockets by the power cable.
- 1.1.9 **DO NOT** use worn or damaged leads, plugs or connections. Immediately replace or have repaired by a qualified electrician. A U.K. 3 pin plug with ASTA/BS approval is fitted. In case of damage, cut off and fit a new plug according to the following instructions (discard old plug safely).

(UK only - see diagram at right). **Ensure the unit is correctly earthed via a three-pin plug.**

- a) **Connect the GREEN/YELLOW earth wire to the earth terminal 'E'.**
- b) **Connect the BROWN live wire to live terminal 'L'.**
- c) **Connect the BLUE neutral wire to the neutral terminal 'N'.**
- d) **After wiring, check that there are no bare wires, that all wires have been correctly connected, that the cable external insulation extends beyond the cable restraint and that the restraint is tight.**

- 1.1.10 Some products require more than a 13Amp electrical supply. In such a case, NO plug will be fitted. **You must** contact a qualified electrician to ensure that a 30Amp fused supply is available. We recommend you discuss the installation of a industrial round pin plug and socket with your electrician.
- 1.1.11 **Cable extension reels.** When a cable extension reel is used it should be fully unwound before connection. A cable reel with an RCD fitted is recommended since any product which is plugged into the cable reel will be protected. The section of the cable on the cable reel is important and should be at least 1.5mm², but to be absolutely sure that the capacity of the cable is suitable for this product and for others that may be used in the other output sockets, we recommend the use of 2.5mm² section cable.

WARNING! Be very cautious if using a generator to power the welder. The generator must be self-regulating and stable with regard to voltage, wave form and frequency. The output must be greater than the power consumption of the welder. If any of these requirements is not met the electronics within the welder may be affected.

NOTE: The use of an unregulated generator may be dangerous and will invalidate the warranty on the welder.

WARNING! The welder may produce voltage surges in the mains supply which can damage other sensitive equipment (e.g. computers). To prevent this happening, it is recommended that the welder is connected to a power supply that does not feed any sensitive equipment.

1.2 GENERAL SAFETY

DANGER! Unplug the inverter from the mains power supply before connecting or disconnecting cables or performing maintenance or service. Direct contact with the inverter circuit is dangerous.

- ✓ Keep the inverter and cables in good working order and condition. (Take immediate action to repair or replace damaged parts).
- ✓ Use genuine parts and accessories only. (Non recommended parts may be dangerous and will invalidate the warranty).
- ✓ Locate inverter in a suitable working area. Ensure area has adequate ventilation as welding fumes are harmful.
- **WARNING!** If it is necessary for you to assemble the work clamp cable, ensure that sufficient copper strands are exposed and turned back to make full contact within the dinse plug to ensure a good electrical contact. Loose connection will cause overheating, rapid deterioration and loss in efficiency.
- ✓ Ensure there is no obstruction to the flow of clean cool air through the ventilation apertures and ensure there are no conductive dusts, corrosive vapours or humidity which could enter the inverter and cause serious damage.
- ✓ Keep working area clean and tidy and free from unrelated materials. Also ensure the working area has adequate lighting.
- **WARNING!** Use welding head shield to protect eyes and avoid exposing skin to ultraviolet rays given off by electric arc. Wear safety welding gauntlets.
- ✓ Remove ill fitting clothing, remove ties, watches, rings, and other loose jewellery, and contain long hair.
- ✓ Ensure the workpiece is correctly secured before operating the inverter.
- ✓ Avoid unintentional contact with workpiece. Accidental or uncontrolled switching on of the torch may be dangerous and will cause the nozzle to wear.
- ✓ Keep unauthorised persons away from the working area, and any persons working within the area must wear the same protective items.
- ✓ Operators must receive adequate training before using the inverter.
- ✓ Stand correctly keeping a good footing and balance, ensure the floor is not slippery, and wear non-slip shoes.
- **WARNING!** When unit is switched off wait for 15 seconds whilst capacitors discharge before opening the case.
- x **DO NOT** operate the inverter if it or its cables are damaged.
- x **DO NOT** use welding cables over 10m in length. (Cables should be as short as possible).
- x **DO NOT** attempt to fit any non genuine torches, components, or parts to the inverter unit. To do so could damage your machine and invalidate your warranty.
- x **DO NOT** use any metallic structure which is not part of the workpiece to substitute for the return cable of the welding current. This may jeopardise results and may be dangerous. *Exception:* Metallic work bench, but connect as near to weld as possible.
- x **DO NOT** hit the electrode on the workpiece, this may damage the electrode and make strike-up difficult.
- x **DO NOT** get inverter wet or use in damp or wet locations or areas where there is condensation.
- ▲ **DANGER!** **DO NOT weld near inflammable materials, solids, liquids, or gases.**
- x **DO NOT** weld containers or pipes which have held flammable materials or gases, liquids or solids. Avoid operating on materials cleaned with chlorinated solvents or near such solvents.
- x **DO NOT** pull the inverter by the cable, or the torch, and **DO NOT** bend or strain cables, protect from sharp or abrasive items, and **DO NOT** stand on cables or leads. Protect from heat. Long lengths of slack must be gathered & neatly coiled. **DO NOT** place cables where they may endanger others.

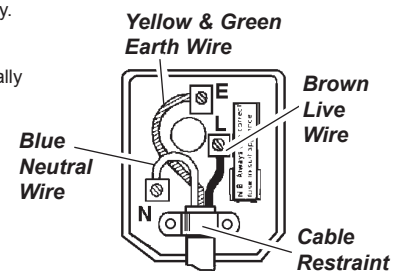

FUSE RATING
13AMP

- X **DO NOT** touch the workpiece close to the weld as it will be very hot. Allow to cool.
- X **DO NOT** touch the torch immediately after use. Allow the torch to cool.
- X **DO NOT** operate inverter when tired or under the influence of drugs, alcohol or intoxicating medication.
- ✓ When not in use store the inverter in a safe, dry, childproof area.

2. DESCRIPTION & SPECIFICATION

2.1 DESCRIPTION.

Fan-cooled DC power supply for TIG and MMA welding applications. Lightweight, compact unit with high quality technology, suitable for welding stainless steel, steel, deoxidised copper, nickel and titanium. TIG cycle included current down-slope regulation. Features HF or lift striking. Includes connector for foot pedal or hand controller for when more control is required. Supplied with shoulder strap.

2.2 GENERAL SPECIFICATION.

Power Output: 5-160A
 Duty Cycle: 25% @ 160A
 Electrode Capacity: Ø1.6 - 3.2mm
 Power Absorbed: 4kW
 Mains Voltage: 230V-1ph
 Insulation Class: H

Protection: IP23
 Weight: 6.8kg
 TIG Accessories included: YES
 ARC Accessory Ref (Optional): INVMMMA2
 Foot Pedal Ref (Optional) INV/TIG/5
 Current Control Ref (Optional) INV/TIG/7

2.3 EXPLANATION OF RATINGS PLATE SYMBOLS.

Detailed technical data relative to the performance of the machine is located on the underside of the base. **Please note** that the ratings plate shown below is an example only intended to assist with the explanations of symbols. To determine the correct technical values of the machine in your possession, you must refer to the machine data plate.

- 1 Case protection grade: IP23. Standard governing the required protection from water ingress and isolation of internal parts from persons and objects.
- 2 Mains symbol : AC - single-phase supply.
- 3 Symbol S: Indicates that welding operations may be carried out in areas with greater risk of electric shock (e.g. close to metal masses).
- 4 Symbol of welding procedure chosen: Manual Arc welding with stick electrode or welding with TIG.
- 5 Symbol of the main internal parts of the welder : i.e. frequency converter (inverter) - transformer - rectifier.

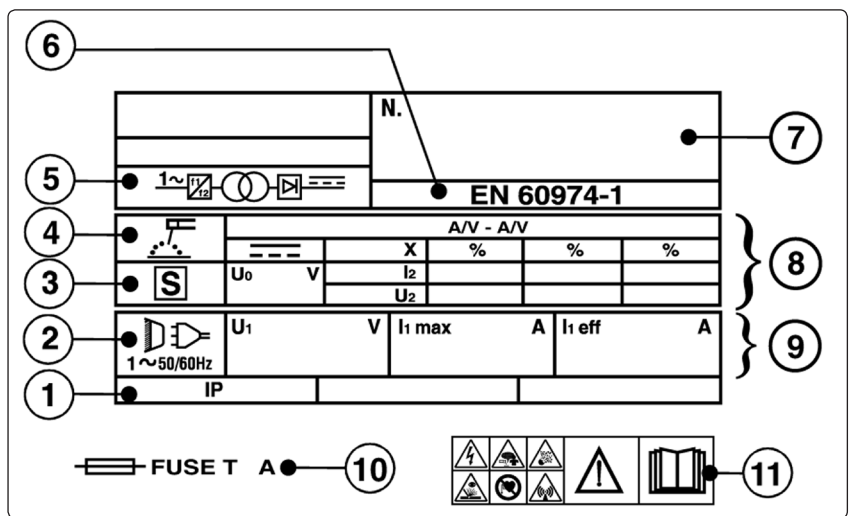

- 6 The EUROPEAN standard relating to safety and the construction of Arc welding machines.
- 7 Manufacturer's identifying serial number.

- 8 **PERFORMANCE OF THE WELDING CIRCUIT.**
U0 : Maximum no-load peak voltage (welding circuit open).
12 / U2 : Current and corresponding normalised voltage that may be supplied from the machine during welding.
X : Duty cycle: Indicates the time during which machine can supply the corresponding current (same column). This is expressed as % on the basis of a 10min. cycle (e.g. 60% = 6 min of work, 4 min. break and so on).
A/V-A/V : Indicates the regulation range of the welding current (maximum - minimum) at the corresponding arc voltage.

- 9 **DATA REGARDING THE MAINS.**
U1 : Alternating current and power supply frequency of the machine (allowed limits + -10%).
I1max : Maximum current absorbed by the line.
I1eff : Effective current supplied.
- 10 Size of delayed action fuses to be used to protect the power line.
- 11 Symbols referring to safety regulations.

2.4. CIRCUIT SYSTEM DESCRIPTION (Refer to fig 1).

1. Mains input (single phase), rectifier unit and condenser.
2. Transistors and drivers switching bridge (IGBT). Turns the mains rectified voltage into high frequency alternating voltage (60khz) and permits power regulation according to the current/voltage of the weld to be done.
3. High frequency transformer: The primary windings are fed by the voltage converted by Block 2. It has the function of adapting voltage and current to values required by the ARC welding procedure and, simultaneously, isolates the welding circuit from the mains.
4. Secondary rectifier bridge with inductance. Changes the alternating voltage/current supplied by secondary windings into continuous current/voltage at a low wave-length.
5. Electronic and regulation board: Instantly checks the value of the welding current against that selected by the user. It modulates the commands of the IGBT drivers, which control regulation.
6. Control logic for welding machine operation: determines the dynamic response of the current while the electrode melts (instantaneous short circuits) and supervises the safety system
7. Panel for setting parameters and operating modes.
8. HF striking generator.
9. Protective gas electrovalve.
10. Remote regulation.

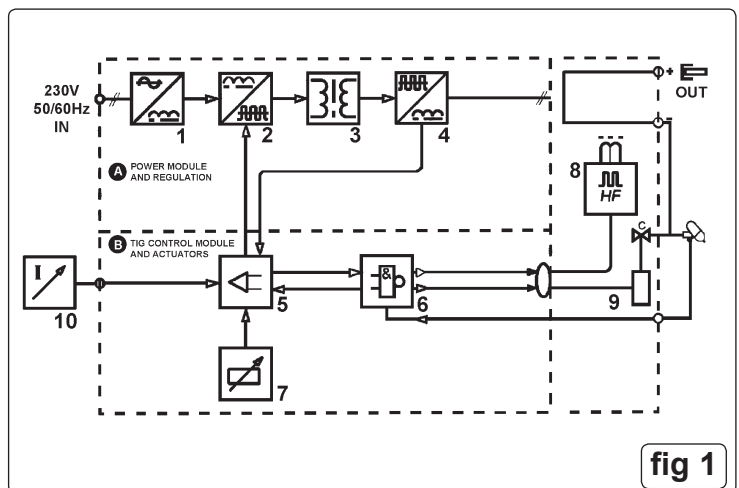

3. CONTROLS

3.1 FRONT PANEL LAYOUT (refer to Figure 2).

1. WELDING CURRENT CONTROL.

Potentiometer has scale graduated in Amps. Also allows adjustment during welding.

2. **TIG START MODE SWITCH.** With the switch to the left 'HF' (high frequency) start mode is selected. With the switch to the right 'LIFT' start mode is selected.

3. **GREEN LED.** Shows that the machine is connected to the mains and ready for operation.

4. **WELDING MODE SWITCH** (three positions).

Selects the type of welding and the torch push button functions in TIG welding mode.

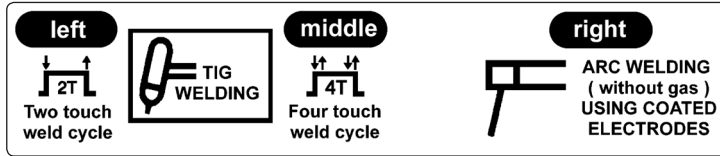

5. **DUAL FUNCTION CONTROL.** During TIG welding this potentiometer is used to adjust 'current slope down time' which occurs after the torch is turned off. During ARC welding (without gas) using coated electrodes the potentiometer is used to adjust 'arc force'.

6. **DINSE SOCKET** (positive +).

For the connection of a welding cable Dinse plug.

7. **DINSE SOCKET** (negative -).

For the connection of a welding cable Dinse plug.

8. **CONNECTOR SOCKET.** For the connection of torch push button cable.

9. **GAS PIPE FITTING.** For the connection of the TIG torch gas tube.

10. **FAULT INDICATOR** (Yellow LED normally off). When ON the welding current is shut off due to one of the following faults:

Thermal protection. The temperature inside the machine is too high. The machine is ON but will not deliver current until it cools to normal temperature. Once this happens it will re-start automatically.

Mains over/under voltage protection. When the mains voltage is either too high or too low the machine is blocked.

Short circuit protection. In case there is a short-circuit lasting more than 1.5 seconds (e.g. electrode striking), the machine stops. The welder will restart automatically.

3.2 REAR PANEL LAYOUT (refer to Figure 3).

11. **MAIN ON/OFF SWITCH** (Illuminated).

12. **MAINS CABLE.**

13. **REMOTE CONTROL CONNECTOR.** See **optional** remote controls shown below.

Pedal Remote control (Model No. INV/TIG/5) - Allows hands free adjustment of the welding current and can also be used to stop and start the weld without using the torch button.

Remote Control with two potentiometers (Model No. INV/TIG/7) - The potentiometer labelled 'Power' allows continuous adjustment of the welding current. The other potentiometer allows adjustment of the 'down slope time' in TIG mode and adjustment of 'arc force' during ordinary arc welding without gas.

14. **GAS INLET FITTING.** For connecting gas cylinder to the welder using clear tubing provided.

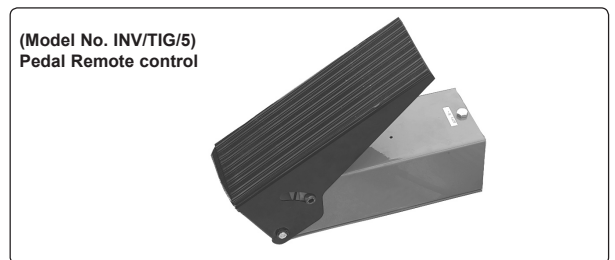
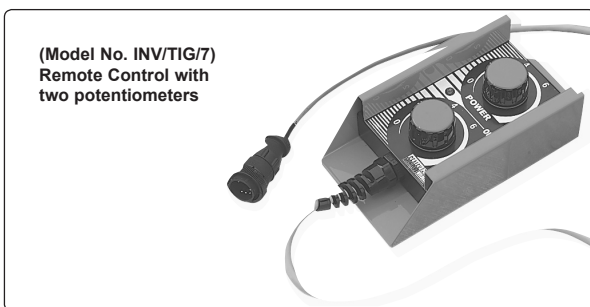
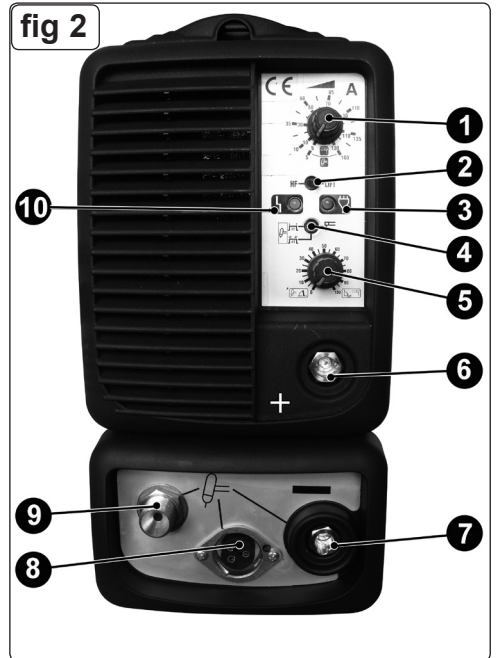

4. PREPARING INVERTER FOR USE

4.1 **CONNECTION TO THE MAINS.** The unit is fitted with a 13Amp plug and is designed to operate in both welding modes on a 13Amp supply. If however the unit is used consistently at high output, connection to a 30Amp supply may be considered. Seek the advice of a qualified electrician on connection to a suitable supply.

4.2 **WELDING CABLE CONNECTIONS.** The torch cable is supplied ready assembled but it may be necessary for you to assemble the work clamp cable. Attach the work clamp to one end of the cable as shown in fig.5. To connect the Dinse Plug as shown in fig.4 first thread the cable through the outer cover of the plug (see fig.4 - 4). Now remove 20mm of insulation sheath from the end of the cable and fold back the copper wire all around the outside of the sheath (1). Push the cable end into the copper sleeve (2) so that the folded back wire makes good contact with the inside of the sleeve. Push the copper sleeve into the brass plug body (3) and tighten the large grub screw until the cable is firmly held. Now slide the outer plug cover up the cable and press the brass body into it as shown in fig.4.

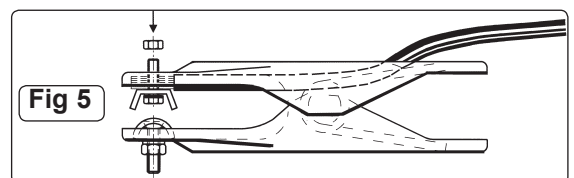
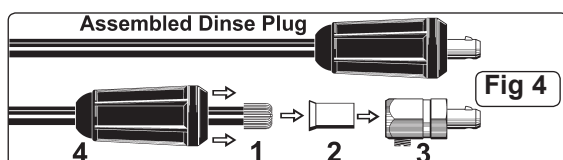

4.3 TIG CONNECTIONS.

“TIG” TORCH CABLE. Dinse plug at the end of the torch cable will be connected to the **negative socket (-)** on the front panel (see fig.2 item 7).

WORK CLAMP CABLE. Dinse plug at the end of the clamp cable will be connected to the **positive socket (+)** on front panel (see fig.2 item 6).

(* Please note that the way the welding cables are connected to the inverter for ordinary ARC welding may be different to the way the cables are connected for standard TIG welding. Whilst most stick electrodes are connected to the positive terminal certain types need to be connected to the negative terminal. It is therefore essential that the user refers to the manufacturer's instructions for the electrodes to ensure that the correct polarity is selected.

4.4 ARC CONNECTIONS. (Requires optional ARC Accessory Kit INV/16)

4.4.1 **ELECTRODE HOLDER.** Plug at the end of electrode cable **will normally (*)** be connected to the **positive socket (+)** on the front panel (see fig.2 item 6).

4.4.2 **WORK CLAMP CABLE.** Plug at the end of the clamp cable **will normally (*)** be connected to the **negative socket (-)** on the front panel (see fig.2 item 7).

4.5 CONNECTING THE GAS.

4.5.1 When using Argon or Argon mixtures fit the Bull Nose Adaptor supplied to the cylinder with a spanner.

4.5.2 Fit the gas regulator onto the Bull Nose Adaptor (see fig.6).

4.5.3 Using the clear tubing supplied connect the regulator to the gas inlet on the back of the inverter (see fig.2 - 13). Hold the tubing securely in place on each connector by using the worm drive clamps supplied.

4.5.4 Open the regulator **before** opening the cylinder valve. Test for leaks.

4.5.5 Set the gas flow to suit the welding parameters required. See tables below for general guidance.

4.5.6 If necessary the gas flow can be adjusted during welding using the regulator knob.

fig 6



4.6 **PREPARATION AND CHOICE OF ELECTRODE.** In order to produce a good weld it is important to choose an electrode of the correct diameter for the current to be used. For a general guide to the settings to be used with particular diameters of electrodes please refer to the tables below. The electrode will normally protrude from the ceramic nozzle by 2 to 3mm but in order to gain access to inaccessible areas such as internal corners the electrode can be made to protrude by up to 8mm. The chosen electrode should be sharpened axially on a grinding wheel as indicated in the diagram to the right. The tip should be perfectly concentric in order to avoid arc deviations. The condition of the electrode should be regularly inspected to maintain it in peak condition.

4.7 **PREPARATION OF THE WORKPIECE.** For a good weld it is important that the workpiece is thoroughly cleaned so that no oxides, oil, grease or solvents remain on the surface of the material.

4.8 TIG WELDING PARAMETERS.

TIG WELDING PARAMETERS FOR STAINLESS STEEL

Thickness (mm)	Current (A)	Electrode (diam mm)	Nozzle (diam mm)	Argon (L/min)	Filler Rod (diam mm)
0.5 - 0.8	15 - 30	1	6.5	3	---
1	30 - 60	1	6.5	3 - 4	1
1.5	70 - 100	1.6	9.5	3 - 4	1.5
2	90 - 110	1.6	9.5	4	1.5 - 2.0
2.5	110 - 130	1.6	9.5	5	1.5 - 2.0
3	120 - 150	1.6 - 2.4	9.5	5 - 6	2 - 3

TIG WELDING PARAMETERS FOR DEOXIDISED COPPER

Thickness (mm)	Current (A)	Electrode (diam mm)	Nozzle (diam mm)	Argon (L/min)	Filler Rod (diam mm)
0.5 - 0.8	20 - 30	1	6.5	4	---
1	80 - 100	1.6	9.5	6	1.5
1.5	110 - 140	1.6	9.5	6	1.5

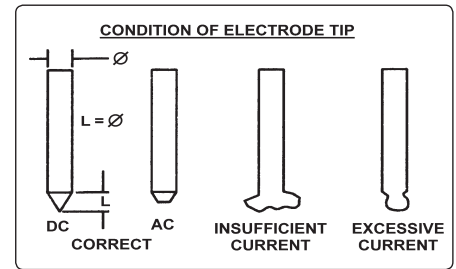

4.9 CARRYING STRAP.

If not already fitted, follow the carrying strap assembly as pictured in figure 7.

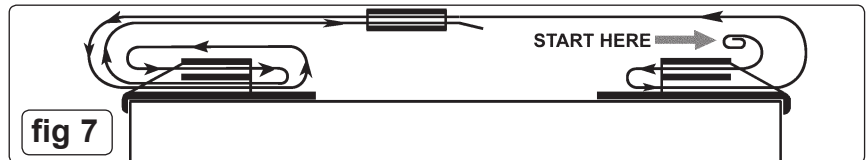

5. ELECTROMAGNETIC COMPATIBILITY

THIS EQUIPMENT IS IN CONFORMITY WITH THE EUROPEAN STANDARD EN 50199 : - ELECTROMAGNETIC COMPATIBILITY OF ARC WELDING EQUIPMENT AND SIMILAR PROCESSES (e.g. ARC AND TIG WELDING)

5.1 **PROTECTION AGAINST INTERFERENCE (E.M.C.).** The emission limits in this standard may not, however, provide full protection against interference to radio and television reception when the welding equipment is used closer than 30m to the receiving antenna. In special cases, when highly susceptible apparatus is being used in close proximity, additional mitigation measures may have to be employed in order to reduce the electromagnetic emissions. At the same time there could occur some potential difficulties in having electromagnetic compatibility in a non-industrial environment (e.g. in residential areas). Therefore it is most important that the welding equipment is used and installed according to the following instructions:

5.2 **INSTALLATION AND USE.** The user is responsible for installing and using the welding equipment according to these instructions. If electromagnetic disturbances are detected, then it shall be the responsibility of the user of the welding equipment to resolve the situation with the technical assistance of the supplier. In some cases this remedial action may be as simple as earthing the circuit (see Note *). In other cases it could involve constructing an electromagnetic screen enclosing the welding power source and the work complete with associated input filters. In all cases the electromagnetic disturbances shall be reduced to the point where they are no longer troublesome.

Note * The welding circuit may or may not be earthed for safety reasons. Changing the earthing arrangements should only be authorised by a person who is competent to assess whether the changes will increase the risk of injury, e.g. by allowing parallel welding circuit return paths which may damage the earth circuits of other equipment. Further guidance is given in IEC 974-13, 'Arc welding equipment - Installation and use.'

5.3 **ASSESSMENT OF AREA.** Before installing welding equipment the user shall make an assessment of potential electromechanical problems in the surrounding area. The following shall be taken into account :

- Other supply cables, control cables, signalling and telephone cables, above, below and adjacent to the welding equipment.
- Radio and television transmitters and receivers.
- Computer and other control equipment.
- Safety critical equipment, e.g. Security monitoring of industrial equipment.
- The health of people in the vicinity, e.g. Persons fitted with a pacemaker or hearing aid.
- Equipment used for calibration or measurement.
- The immunity of other equipment in the environment. The user shall ensure that other equipment being used in the environment is compatible. This may require additional protective measures.
- The time of day that welding and other activities are to be carried out.
- The size of the surrounding area to be considered will depend on the structure of the building and other activities that are taking place. The surrounding area may extend beyond the boundaries of the premises.

5.4 **MAINS SUPPLY.** The inverter should be connected to the mains supply according to these instructions. If interference occurs, it may be necessary to take additional precautions such as filtering of the mains supply. Consideration should also be given to shielding the supply cable of permanently installed welding equipment, in metallic conduit or equivalent. This shielding should be connected to the welding power source so that good electrical contact is maintained between the conduit and the welding power source enclosure.

- 5.5 MAINTENANCE OF THE WELDING EQUIPMENT.** The welding equipment should be routinely maintained according to these instructions. All access and service door covers should be closed and properly fastened when the welding equipment is in operation. The welding equipment should not be modified in any way except for those changes and adjustments covered in these instructions. In particular, the spark gaps of arc striking and stabilising devices should be adjusted and maintained according to these instructions.
- 5.6 WELDING CABLES.** The welding cables should be kept as short as possible and should be positioned close together, running at or close to the floor level.
- 5.7 EQUIPOTENTIAL BONDING.** Bonding of all metallic components in the welding installation and adjacent to it should be considered. However, metallic components bonded to the workpiece will increase the risk that the operator could receive a shock by touching these metallic components and the electrode at the same time. The operator should be insulated from all such bonded metallic components.
- 5.8 EARTHING OF THE WORKPIECE.** Where the workpiece is not bonded to earth for electrical safety, nor connected to earth because of its size and position, e.g. ship's hull or building steelwork, a connection bonding the workpiece to earth may reduce emissions in some, but not all instances. Care should be taken to prevent the earthing of the workpiece increasing the risk of injury to others or damage to other electrical equipment. Where necessary, the connection of the workpiece to earth should be made by a direct connection to the workpiece, but in some countries where direct connection is not permitted, the bonding should be achieved by a suitable capacitance, selected according to national regulations.
- 5.9 SCREENING AND SHIELDING.** Selective screening and shielding of other cables and equipment in the surrounding area may alleviate problems of interference. Screening of the entire welding installation may be considered for special applications.

6. TIG WELDING PRINCIPLES & FEATURES

If you have no welding experience we recommend that you seek training from an expert source before using this equipment. Good TIG welding may only be achieved with continued supervised practice. Before commencing welding read the safety instructions in Section 1.

- 6.1 TIG WELDING - GENERAL PRINCIPLES OF OPERATION.** The TIG welding procedure uses the heat produced by an electric arc, struck and maintained between a Tungsten electrode and a workpiece to soften and fuse the workpiece metal, usually in conjunction with a suitable filler rod. The electrode is held in an insulated torch which transmits the welding current to the electrode. The torch also has a gas connection which allows an inert gas (usually Argon) to be dispensed from a ceramic nozzle surrounding the electrode. This produces a shroud of gas around the welding process which protects the electrode and molten weld pool from oxidation.
- 6.2 CURRENT DOWN SLOPE FACILITY.** The welder also has a "current down slope" facility which if used gives a gradual turning off of the current. This function is particularly useful for avoiding the formation of a crater at the end of a weld as the filler rod is still consumed during the 'down slope' phase.
- 6.2.1** On thin pre-prepared material (up to 1mm) welding can be achieved without a filler rod by fusing the edges of the metal together. Most welding however will be done using a filler rod to complete a joint. This rod is melted in the weld pool but should not make contact directly with the electrode. *It is essential that operators wear adequately insulated gloves to protect themselves from both the heat of the welding process, metal spatter and any direct contact with the electrode.*
- 6.2.2** The Tungsten electrode will be consumed during the welding process but at a very slow rate. The tip of the electrode must be periodically inspected and re-ground if necessary to ensure continued efficient welding. See diagram 'Condition of electrode tip'.
- 6.3 TORCH DUAL FUNCTION PUSH BUTTON.** The torch push button can control the switching of the power in two different modes depending on your welding requirements. These modes are selected using the small toggle switch on the front panel. (See fig.2-2)
- 6.3.1 Two touch weld cycle.** In this mode the push button is pressed and held down to strike the arc and to continue welding. When the end of the weld is reached the push button is released and the arc is switched off. The current 'down slope' function can be used in this mode if required.
- 6.3.2 Four touch weld cycle.** This mode allows you to complete long welds without having to continuously hold down the torch button and affords a degree of control over the weld current using the torch button (See Rapid Touch Function). The push button is first held down which strikes the arc and then provides power at a base current level as long as the button continues to be held down. Once the push button is released the current rises to the level set by the welding current control and stays at this level even though the push button has been released. If the button is then pressed and held down again the current will decrease to the base level and remain there whilst the button is held. When the button is released the current is turned off.
- 6.3.3 Rapid touch function.** This function is available in four touch mode only. During the course of welding at the current you have set (with the torch button released) the current can be made to dip down towards base current and back again by momentarily pressing and releasing the torch button. This function can be used as a sequence of rapid presses which can help to control heat and penetration during difficult welds. At the end of a rapid sequence of presses when the button is released, the current will remain at the weld current set and the welder will continue to function as previously described in four touch mode.

7. TIG WELDING PROCEDURE

- WARNING! Use welding head shield to protect eyes and avoid exposing skin to ultraviolet rays given off by electric arc. Wear safety welding gauntlets.**

If difficult welds are to be performed and the welding parameters are unknown, it is advisable to carry out several trial runs on test pieces in order to determine the right welding current and gas flow.

SWITCH ON the welder only when you are satisfied that the welder is correctly connected and the work to be done is fully prepared.

7.1 SETTING THE CONTROLS.

- 7.1.1** Set the required gas flow using the knob on the gas regulator.
- 7.1.2** Select either the 'two touch welding mode' or the 'four touch welding mode' using the miniature toggle switch on the front panel.
- 7.1.3** Set the 'current down slope' if required.

7.2 STRIKING THE ARC.

- 7.2.1** Set the miniature toggle switch (see fig.2-4) to the left hand position for HF (high frequency) strike mode and to the right hand position for LIFT strike mode.
- 7.2.2 HF strike mode.** Press and hold the torch button bringing the electrode tip to within 2 to 3mm of the workpiece. The arc will be struck by high frequency impulses. When the arc is established, form a molten pool on the workpiece, introduce the filler rod and proceed along the joint. When the arc is difficult to strike, despite the presence of gas and visible high frequency discharges it is not advisable to carry on for any length of time. Before continuing, check the integrity of the electrode surface and tip and if necessary regrind the tip.
- 7.2.3 LIFT strike mode.** Lightly touch the workpiece with the electrode tip. Fully depress the torch button and lift the electrode 2 to 3mm from the workpiece thus obtaining the arc.
- 7.2.4** To cease welding release the torch button.
- 7.2.5 SWITCH OFF** the welder and turn off the gas at the cylinder valve.

8. ARC WELDING PROCEDURE

The TIG160HF will also perform ordinary ARC welding (without gas) using coated electrodes. (Requires optional ARC Accessory Kit INV/16)

Please note that the way the welding cables are connected to the inverter for ordinary Arc welding may be different to the way the cables are connected for standard TIG welding. Whilst most stick electrodes are connected to the positive terminal certain types need to be connected to the negative terminal. It is therefore essential that the user refers to the electrode manufacturers instructions to ensure that the correct polarity is selected.

8.1 SETTING THE WELDING CURRENTS.

The mechanical characteristics of the weld will be determined not only by the current used but also by other factors such as the diameter and quality of the electrode itself as well as the arc length, the speed of welding and the orientation of the electrode to the work surface. Unused electrodes should also be protected from moisture as a damp electrode will affect the quality of the weld.

- 8.1.1** The following table gives a general guide to the minimum and maximum welding currents to be used with the different diameter electrodes.
- | | Electrode diameter
(mm) | Welding current | | |
|---|----------------------------|-----------------|---|------|
| | | Min. | - | Max. |
| 8.1.2 Depending on the diameter of the electrode the current used will have to be varied depending on the orientation of the workpiece itself. Higher current values will be used for flat welding whereas the current will have to be reduced for vertical or overhead welding. | 1.6 | 25 | - | 50 |
| | 2 | 40 | - | 80 |
| | 2.5 | 60 | - | 110 |
| 8.1.3 The current down slope function is not used during ordinary Arc welding and the potentiometer should be set to zero. | 3.2 | 80 | - | 160 |

- **WARNING! Use welding head shield to protect eyes and avoid exposing skin to ultraviolet rays given off by electric arc. Wear safety welding gauntlets.**
If difficult welds are to be performed and the welding parameters are unknown, it is advisable to carry out several trial runs on test pieces in order to determine the right welding current and gas flow.
- 8.2 **SWITCH ON** the welder only when you are satisfied that the welder is correctly connected and the work to be done is fully prepared.
- 8.3 **SETTING THE CONTROLS.**
- 8.3.1 Select the right hand position on the miniature toggle switch (see fig.2.2) on the front panel which is the arc welding mode.
- 8.3.2 Set the welding current required.
- 8.4 **STRIKING THE ARC.** Strike the electrode tip on the workpiece as if you were striking a match (Do not hit the electrode on the workpiece as this could damage the electrode and make strike-up difficult).
- 8.5 **WELDING.**
- 8.5.1 As soon as the arc is ignited try to maintain a distance from the workpiece equal to the diameter of the electrode in use and maintain this distance throughout the duration of the weld. Remember that the angle of the electrode as it advances should be 20° to 30° from a vertical line over the workpiece.
- 8.5.2 At the end of the weld bead, move the electrode backwards in order to fill the weld crater and then quickly lift the electrode from the weld pool in order to extinguish the arc.
- 8.6 **SWITCH OFF** the welder after use.

9. MAINTENANCE

- ▲ **DANGER! Unplug the inverter from the mains power supply before connecting or disconnecting cables or performing maintenance or service. Direct contact with the inverter circuit is dangerous.**

9.1 GENERAL MAINTENANCE.

- 9.1.1 To avoid a build up of dust inside the machine which may block or restrict the ventilation system, periodically remove the covers and remove the dust with a low pressure air jet or vacuum cleaner. Replace covers immediately. Under no circumstances should the machine be operated with the covers removed.
- 9.1.2 Avoid resting the torch and its associated cable on any hot surfaces. If the insulation is damaged in any way the torch cannot be used.
- 9.1.3 Periodically check the condition of the gas tubing and the connections.
- 9.1.4 In the event of any problems of unsatisfactory weld performance please first go through the trouble shooting procedure shown below. If this does not solve the problem the Inverter must be taken to a qualified and authorised service agent for repair. Contact your local Sealey dealer for service.

10. TROUBLESHOOTING

10.1 TIG WELDING.

- 10.1.1 **Yellow fault indicator is illuminated.** When this LED indicator is on the current has been shut off for one of the following reasons:
 - a) **Inverter has overheated.** Leave the machine to cool to normal temperature at which point it will reset itself automatically. Do not restart the inverter until the reason for overheating has been understood and solved (see below).
 - b) **Voltage is too high or too low.** If the supply voltage drops below 190V AC or rises above 260V AC the machine is turned off. *Reconnect the inverter to a more stable supply of 230V AC.*
 - c) **Short circuit has occurred.** If a short circuit has occurred lasting more than 1.5 seconds (e.g. during the striking of the arc) the inverter is switched off. *In this case, wait for the inverter to restart automatically.*
- 10.1.2 **Overheating.** This may occur for one of the following reasons:
 - a) Inverter casing is full of dust making cooling system inefficient. *Clean as described in section 9.1.*
 - b) Fan not working. *Have fan renewed by authorised service agent.*
 - c) Electrode does not match the collet and collet body fitted within the torch. *Obtain and fit the correct size of torch components for the electrode selected.*
 - d) Bad connection in welding cable and/or work clamp has made poor connection with workpiece. *Check and clean all connections..*
- 10.1.3 **Poor weld quality.**
 - a) Refer to weld bead diagrams.
 - b) Check condition of electrode. It should be ground to the correct shape as seen in section 4 and should be symmetrically conical.
 - c) Check that correct gas flow is being used.
 - d) Check that correct ceramic nozzle is fitted to torch.
- 10.1.4 **Difficulty in striking an arc.**
This is usually due to the electrode not being in good condition. Grind to correct shape or replace.

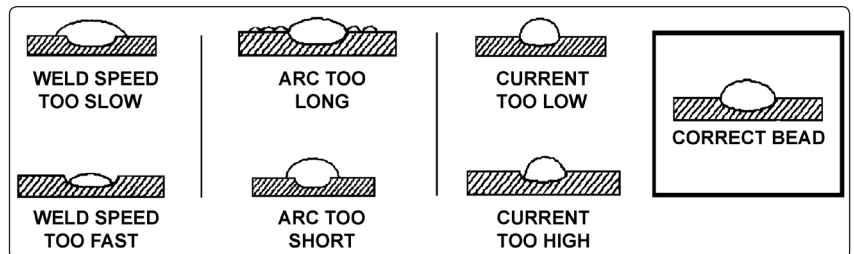

10.2 ARC WELDING.

- 10.2.1 **Burning through thin metal.** On very thin sheet, e.g. car body work, the lowest amperage setting may be too fierce. In this case revert to TIG welding.
- 10.2.2 **Machine cuts out.** Refer to fault indicator information above.
- 10.2.3 **Difficulty in striking an arc.**
 - a) The electrode is damp. Heat it up to 60° - 70° before using.
 - b) Wrong type of rod.

NOTE: It is our policy to continually improve products and as such we reserve the right to alter data, specifications and component parts without prior notice.

IMPORTANT: No liability is accepted for incorrect use of this product.

WARRANTY: Guarantee is 12 months from purchase date, proof of which will be required for any claim.

INFORMATION: For a copy of our latest catalogue and promotions call us on 01284 757525 and leave your full name and address, including postcode.



Sole UK Distributor, Sealey Group,
Kempson Way, Suffolk Business Park,
Bury St. Edmunds, Suffolk,
IP32 7AR

01284 757500

www.sealey.co.uk

01284 703534

sales@sealey.co.uk