

Thank you for purchasing a Sealey product. Manufactured to a high standard this product will, if used according to these instructions and properly maintained, give you years of trouble free performance.

IMPORTANT: PLEASE READ THESE INSTRUCTIONS CAREFULLY. NOTE THE SAFE OPERATIONAL REQUIREMENTS, WARNINGS AND CAUTIONS. USE THE PRODUCT CORRECTLY AND WITH CARE FOR THE PURPOSE FOR WHICH IT IS INTENDED. FAILURE TO DO SO MAY CAUSE DAMAGE AND/OR PERSONAL INJURY AND WILL INVALIDATE THE WARRANTY. PLEASE KEEP INSTRUCTIONS SAFE FOR FUTURE USE.

1. SAFETY INSTRUCTIONS

- ✓ Familiarise yourself with the application and limitations, as well as the potential hazards of the spray gun.
- ❑ **WARNING!** Disconnect the spray gun from the air supply before changing accessories, servicing or performing any maintenance.
- ✓ Maintain the spray gun in good condition (use an authorised service agent).
- ✓ Replace or repair damaged parts. **Use recommended parts only. Unauthorised parts may be dangerous and will invalidate the warranty.**
- ✓ Locate the spray gun in a suitable work area, keep area clean and tidy and free from unrelated materials, ensuring that there is adequate ventilation and lighting.
- ✓ Keep the spray gun clean for best and safest performance.
- ✓ Ensure the air system has sufficient output for the spray gun air consumption (see specification).
- ✓ Wear approved respiratory protection, safety eye goggles and skin protection.
- ✓ Remove ill fitting clothing. Remove ties, watches, rings and other loose jewellery and tie back long hair.
- ✓ Keep children and unauthorised persons away from the work area.
- ✓ When gun is not in use ensure the air supply is disconnected.
- ✓ Avoid unintentional operation.
- ✓ **DO NOT** paint where there is any source, or possible source, of ignition as paint mist is extremely flammable.
- ✗ **DO NOT** point spray gun at yourself or at other persons or animals.
- ✗ **DO NOT** carry the by the air hose, or yank the hose from the air supply.
- ✗ **DO NOT** use the spray gun for any purpose other than for which it is designed.
- ✗ **DO NOT** allow untrained persons to operate the spray gun.
- ✗ **DO NOT** get the spray gun wet or use in damp or wet locations or areas where there is condensation.
- ✗ **DO NOT** operate gun if any parts are missing or damaged as this may cause failure and/or personal injury.
- ✗ **DO NOT** direct air from the air hose at yourself or others.



2. INTRODUCTION & SPECIFICATIONS

Ideal for applying base coats. Features adjustable paint flow and fan width controls. Supplied with aluminium cam action suction feed pot. Suitable for use with waterborne paints. Alternative set-ups available separately.

- Standard Set Up: 1.5mm
- Available Set ups: 1.2, 1.8, 2.0, 2.2 & 2.5mm
- Nominal Operating Air Pressure: 50psi
- Nominal Air Consumption: 5 - 11cfm
- Pot Capacity: 0.8l
- Air Connection 1/4" BSP

3. AIR SUPPLY CONNECTION

- 3.1. For recommended hook-up, see diagram (fig.1).
- 3.2. Ensure the trigger is in the "off" position before connecting to the air supply.
- 3.3. You will require an air supply capable of providing a pressure 50psi and an air volume of 11cfm to operate the gun.
- 3.4. ❑ **WARNING! Ensure the air supply is clean and is regulated to a maximum of 50psi. Too high an air pressure and unclean air will shorten the life of the gun due to excessive wear and may be dangerous, causing damage and/or personal injury.**
- 3.5. Drain the air supply tank and pressure regulator daily. Water in the air line will damage the gun and contaminate the paint.
- 3.6. Clean the compressor air inlet filter weekly.
- 3.7. Line pressure should be increased to compensate for unusually long air hoses (over 8 metres). The minimum hose diameter should be 10mm (3/8") I.D. and fittings must have the same inside dimensions.
- 3.8. Keep hose away from heat, oil and sharp edges. Check hoses for wear and make certain that all connections are secure.

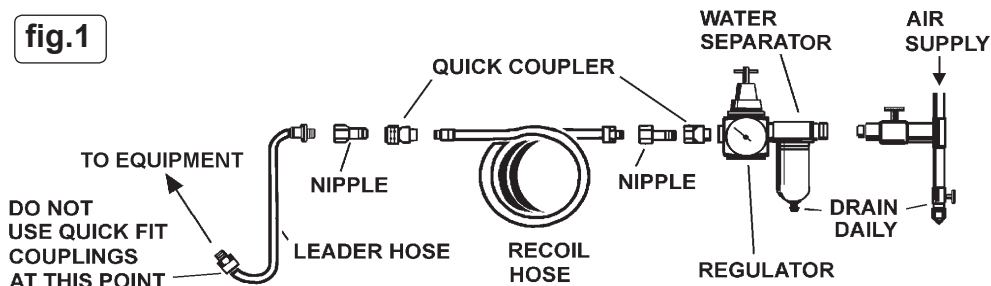

4. OPERATING INSTRUCTIONS

Ensure that you have read and understood the Safety Instructions in Section 1

- 4.1. For best results the gun must be handled and operated correctly. It should be held perpendicular to the surface being sprayed and moved parallel to it. Start the stroke before squeezing the trigger and release the trigger before finishing the stroke. This will enable you to accurately control the gun and paint (fig. 2).
- 4.2. Spray from a distance of about 150 (6") to 250mm (10") depending on the material and the atomizing pressure. The paint deposited should always be even and wet. Each stroke must overlap the preceding stroke to obtain a uniform finish. To reduce over-spray and obtain maximum efficiency, spray with the lowest effective atomizing air pressure.
- 4.3. Controlling the fan spray and the paint:
 - a) Use the paint control knob (fig. 3.A) to increase or decrease the paint flow.
 - b) Fig. 3.B is the air input control and should be set to the lowest effective flow.
 - c) Turn the air cup (fig. 4.1) to achieve a horizontal or vertical fan spray. Lock the cup with retaining ring (fig. 4 2).
 - d) In normal operation, the wings on the cup are horizontal as fig. 4. This provides a vertical fan-shaped pattern (fig. 5) which gives the optimum coverage when moving the gun back and forth, parallel to the work surface.

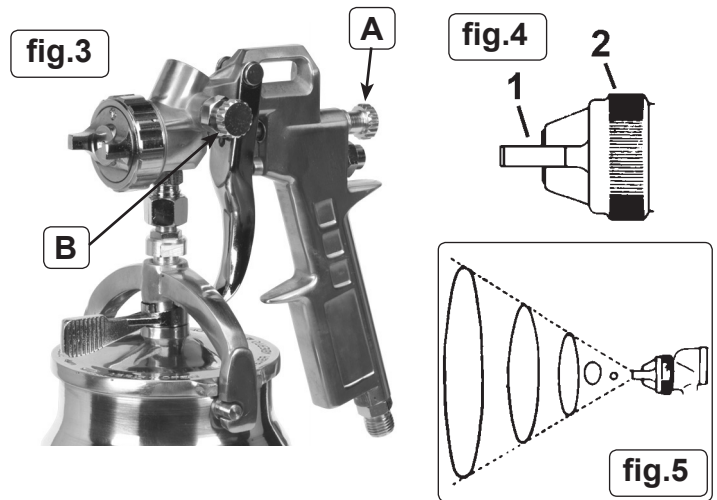
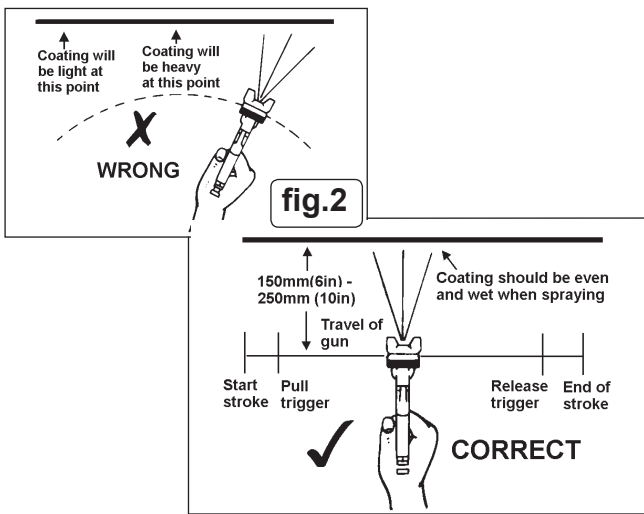

5. CLEANING & MAINTENANCE

IT IS VERY IMPORTANT TO ENSURE THAT THE GUN IS CORRECTLY CLEANED AFTER EACH USE.

Disconnect from the air supply before attempting any cleaning, other than flushing, or maintenance.

5.1. Cleaning the gun



- 5.1.1 Clean out pot with clean solvent.
- 5.1.2 Flush the gun thoroughly with solvent and clean the nozzle with solvent and a brush. **DO NOT** immerse/soak the nozzle in solvent.
- 5.1.3 **DO NOT** immerse the entire gun in solvent. This will cause lubricants to dissolve and packing to dissolve or dry out.
- 5.1.4 Wipe the outside of the gun with a solvent-dampened rag.
- 5.1.5 If you need to clear blocked orifices, only use a non metallic probe that is softer than brass.

5.2. Maintenance

- 5.2.1 Lubricate the fluid needle packing, air valve packing and trigger pivot point daily with a light machine oil.
 - 5.2.2 If you change the nozzle size, ensure the complete nozzle set is exchanged. Insert paint nozzle before putting the paint needle in.
- NOTE:** Take care when re-assembling. Screw parts hand tight to avoid cross-threading. If a part cannot easily be turned by hand, check that you have the correct part, or unscrew, realign and try again. **DO NOT** use excessive force when re-assembling.

6. TROUBLESHOOTING

A faulty spray is usually caused by improper cleaning or dried material around the fluid nozzle tip or in the air cup - use a brush and solvent to remove. Never use metal instruments to clean the air cup or paint nozzle. These parts are carefully machined and any damage to them will cause a faulty spray. If either the air cup or paint nozzle is damaged, the part must be replaced before a perfect spray can be obtained.

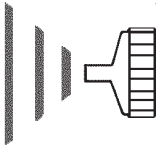
VIEW OF PROBLEM	POSSIBLE REASON FOR PROBLEM	SOLUTION
	Dried material in a dirty side port restricts passage of air. Greater flow of air from the cleaner side port forces the fan pattern in the direction of the clogged side.	Dissolve material in the side ports with solvent, then blow the gun clean. Do not poke the orifice with a metal instrument.
	Dried material around the outside of the fluid nozzle tip restricts the passage of atomizing air at one point through the centre opening of the air cup and results in the pattern shown. This pattern can also be caused by a loose air cup.	Remove the air cup and wipe off fluid tip using a rag dampened with solvent. Tighten the air cup.
	A split spray or one that is heavy at each end of the fan pattern and weak in the middle is usually caused by too high an atomization air pressure or by attempting to get too wide a spray with thin paint.	Check supply pressure and reduce if over 50psi. Adjust the air atomisation valve to reduce pressure and adjust paint needle if required. Check spray pattern on a test panel.
	<ol style="list-style-type: none"> 1. Worn needle packing permits air to get into the fluid passageway. This results in spitting. 2. Dirt between the paint nozzle seat and body or a loose paint nozzle will cause the gun to spit. 3. A loose or defective joint between the pot and gun can cause spitting. 	<ol style="list-style-type: none"> 1. Tighten the packing screw or, in severe cases, replace the packing. 2. Remove the fluid nozzle, clean the back of the nozzle and the nozzle seat in the gun body using a rag dampened with solvent. 3. Tighten or replace.

NOTE: It is our policy to continually improve products and as such we reserve the right to alter data, specifications and component parts without prior notice.

IMPORTANT: No liability is accepted for incorrect use of this product.

WARRANTY: Guarantee is 12 months from purchase date, proof of which will be required for any claim.

INFORMATION: For a copy of our latest catalogue and promotions call us on 01284 757525 and leave your full name and address, including postcode.



Sole UK Distributor, Sealey Group,
Kempson Way, Suffolk Business Park,
Bury St. Edmunds, Suffolk,
IP32 7AR



01284 757500



www.sealey.co.uk



01284 703534



sales@sealey.co.uk