



INSTRUCTIONS FOR: AIR COOLER/HEATER/AIR PURIFIER/ HUMIDIFIER MODEL No: SAC41.V2

Thank you for purchasing a Sealey product. Manufactured to a high standard this product will, if used according to these instructions and properly maintained, give you years of trouble free performance.

IMPORTANT: PLEASE READ THESE INSTRUCTIONS CAREFULLY. NOTE THE SAFE OPERATIONAL REQUIREMENTS, WARNINGS & CAUTIONS. USE THE PRODUCT CORRECTLY AND WITH CARE FOR THE PURPOSE FOR WHICH IT IS INTENDED. FAILURE TO DO SO MAY CAUSE DAMAGE AND/OR PERSONAL INJURY AND WILL INVALIDATE THE WARRANTY. PLEASE KEEP THESE INSTRUCTIONS SAFE FOR FUTURE USE.

1. SAFETY INSTRUCTIONS

1.1. ELECTRICAL SAFETY

WARNING! It is the responsibility of the owner and the operator to read, understand and comply with the following:

You must check all electrical products, before use, to ensure that they are safe. You must inspect power cables, plugs, sockets and any other connectors for wear or damage. You must ensure that the risk of electric shock is minimised by the installation of appropriate safety devices. A Residual Current Circuit Breaker (RCCB) should be incorporated in the main distribution board. We also recommend that a Residual Current Device (RCD) is used. It is particularly important to use an RCD with portable products that are plugged into a supply which is not protected by an RCCB. If in any doubt consult a qualified electrician. You may obtain a Residual Current Device by contacting your Sealey dealer. You must also read and understand the following instructions concerning electrical safety.

- 1.1.1. The Electricity at Work Act 1989 requires that all portable electrical appliances, if used on business premises, are tested by a qualified electrician, using a Portable Appliance Tester (PAT), at least once a year.
- 1.1.2. The Health & Safety at Work Act 1974 makes owners of electrical appliances responsible for the safe condition of those appliances and the safety of the appliance operators. If in any doubt about electrical safety, contact a qualified electrician.
- 1.1.3. Ensure that the insulation on all cables and on the appliance is safe before connecting it to the power supply. See 1.1.1. and 1.1.2. and use a Portable Appliance Tester.
- 1.1.4. Ensure that cables are always protected against short circuit and overload.
- 1.1.5. Regularly inspect power supply cables and plugs for wear or damage and check all connections to ensure that none is loose.
- 1.1.6. Important: Ensure that the voltage marked on the appliance matches the power supply to be used and that the plug is fitted with the correct fuse - see fuse rating at right.
- 1.1.7. **DO NOT** pull or carry the appliance by the power cable.
- 1.1.8. **DO NOT** pull the plug from the socket by the cable.
- 1.1.9. **DO NOT** use worn or damaged cables, plugs or connectors. Immediately have any faulty item repaired or replaced by a qualified electrician. When a BS 1363/A UK 3 pin plug is damaged, cut the cable just above the plug and dispose of the plug safely.
Fit a new plug according to the following instructions (UK only).
 - a) Connect the GREEN/YELLOW earth wire to the earth terminal 'E'.
 - b) Connect the BROWN live wire to the live terminal 'L'.
 - c) Connect the BLUE neutral wire to the neutral terminal 'N'.d) After wiring, check that there are no bare wires, that all wires have been correctly connected, that the cable outer insulation extends beyond the cable restraint and that the restraint is tight.
Double insulated products, which are always marked with this symbol , are fitted with live (brown) and neutral (blue) wires only. To rewire, connect the wires as indicated above - DO NOT connect either wire to the earth terminal.
- 1.1.10. Products which require more than 13 amps are supplied without a plug. In this case you must contact a qualified electrician to ensure that a suitably rated supply is available. We recommend that you discuss the installation of an industrial round pin plug and socket with your electrician.
- 1.1.11. If an extension reel is used it should be fully unwound before connection. A reel with an RCD fitted is preferred since any appliance plugged into it will be protected. The cable core section is important and should be at least 1.5mm², but to be absolutely sure that the capacity of the reel is suitable for this product and for others which may be used in the other output sockets, we recommend the use of 2.5mm² section cable.

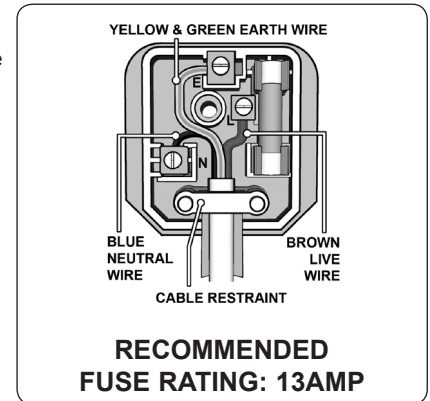

1.2. GENERAL SAFETY

- ✓ Check that the unit is in sound condition and good working order. *Take immediate action to repair or replace damaged parts.*
- ✓ Use recommended parts only. *Unauthorised parts may be dangerous and will invalidate the warranty.*
- x **DO NOT** stand or place **any** object less than 20cm from the front of the unit, 20cm from the rear and sides of the unit, and 60cm above the unit.
- x **DO NOT** obstruct the air intakes or outlets of the unit, and do not cover with washed clothes.
- x **DO NOT** place any object into the outlets - the unit has a fan running at high speed, contact with this will cause injury.
- x **DO NOT** operate the unit when you are tired or under the influence of alcohol, drugs or intoxicating medication.
- x **DO NOT** switch the unit off by disconnecting it from the mains. **ALWAYS** switch to the "OFF" position first.
- x **DO NOT** remove the float lever from the water collection tank.
- x **DO NOT** connect or disconnect the plug from the mains with wet hands.
- ✓ Always discard the water from the collection tank, **DO NOT** use it for any other purpose.
- ✓ Place the unit on a level and stable surface.
- ✓ To prevent water from freezing, do not use the unit at ambient temperatures below 0°C.
- ✓ Do not use the unit outside.
- ✓ Ensure that heating appliances are not exposed to the flow of air from the unit.
- ✓ Before attempting to move the unit, empty the contents of the water tank. Use side carrying handles when moving unit.
- ✓ Switch off and disconnect unit from the mains before attempting any cleaning or other maintenance work.
- ✓ Ensure that the unit is correctly turned off when not in use, and stored in a safe, dry area, out of reach of children.

2. SPECIFICATION

Motor Power:	230V	Maximum Air Flow:	350mtr ³ /hr
Cooler:	70W	Cooling Water Tank:	8.0ltr
Heater:	1000W/2000W	Weight:	6.5kg
Anion Density:	2 million/cm ³		

Multifunction 4-in-1 unit comprising Air Cooler, Heater, Humidifier and Air Purifier. Features a 3-speed fan, adjustable airflow direction and timer. Refrigerant-free cooling is achieved by evaporating water, which can be enhanced by adding ice. Fan-assisted heating function with two settings. Air purification is achieved by negative ion generation and an activated carbon filter. Supplied with electronic remote control. Mounted on castors for manoeuvrability.

3. OPERATION

3.1. CONTROL PANEL FUNCTIONS.

3.1.1. Heat/Cool Air Selection Control (on side of unit - fig.1)

Before the heater functions can be used this lever must be moved to the HEAT position. When the cooling functions are required move the lever to the COOL position.

3.1.2. Timer

By pressing the timer button, the timer can be set to switch off the unit, in periods of time from 0.5 to 7.5 hours in half hour increments. As you press the button the four indicator lights above it will illuminate in different combinations. The time period selected is indicated by adding together the time values above each illuminated light. To turn the timer off, advance the timer setting to 7.5 hours (all four lights illuminated), then press the button once more and the timer is switched off.

NOTE: If the timer is not selected, the unit will continue to work in the mode that it is set, until the unit is switched off manually.

3.1.3. Wind

The direction of the air flow coming out of the unit is controlled by two sets of louvres. The horizontal louvres on the front of the machine can be manually adjusted up or down. Behind these louvres is a second set of electrically driven vertical louvres which can be made to oscillate from side to side by pressing the Wind button. An indicator light will illuminate above the button to show that the louvres are working. To cancel the movement, press the button again. The indicator light will go out.

3.1.4. Speed

There are three speeds available: High, Medium, Low. Press the button to cycle through these until the desired speed is reached.

NOTE: In Heat mode, only two fan speeds are available: Medium and Low.

3.1.5. Heat

Before switching to the Heat function, make sure that the air flow control lever is moved to the HEAT position. This unit contains a special heater with a Positive Temperature Coefficient element. Press the button to cycle through the available heating options. One press will illuminate the PTC1 indicator which is equivalent to 1000Watts. A second press will illuminate both PTC1 and PTC2 indicators, which is equivalent to 2000Watts. A third press switches the heater off.

3.1.6. Cool

Before switching to the cooling function make sure that the air flow control lever is moved to the COOL position. Press the button once to activate the cooling function. The 'Icy Breeze' indicator light above the button will illuminate. To stop the cooling function, press the button again and the indicator light will go out.

3.1.7. On/Off

When the unit is plugged in, it will beep to show that it is in Standby mode. Switch the unit on by pressing the ON/OFF button. The power indicator above the button will illuminate.

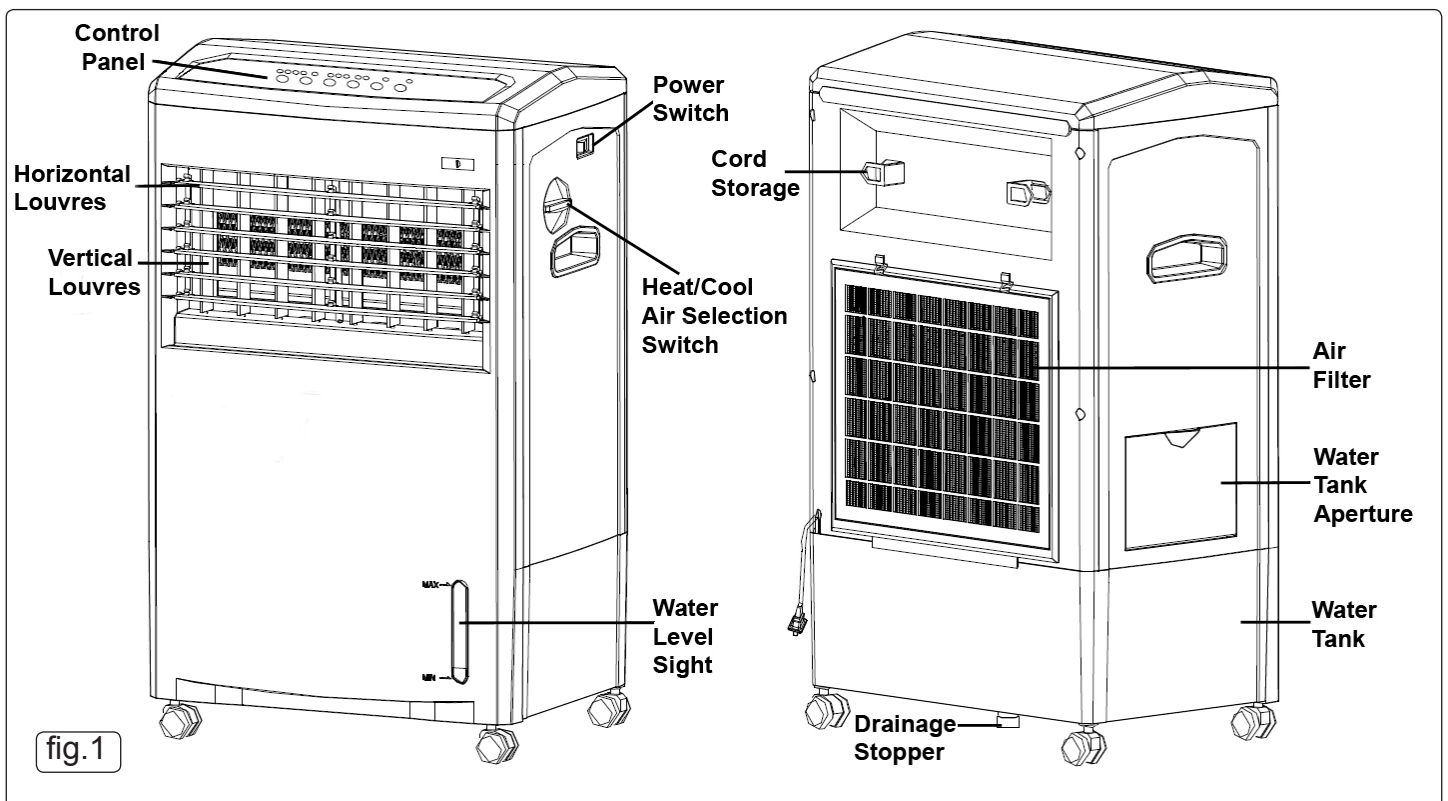

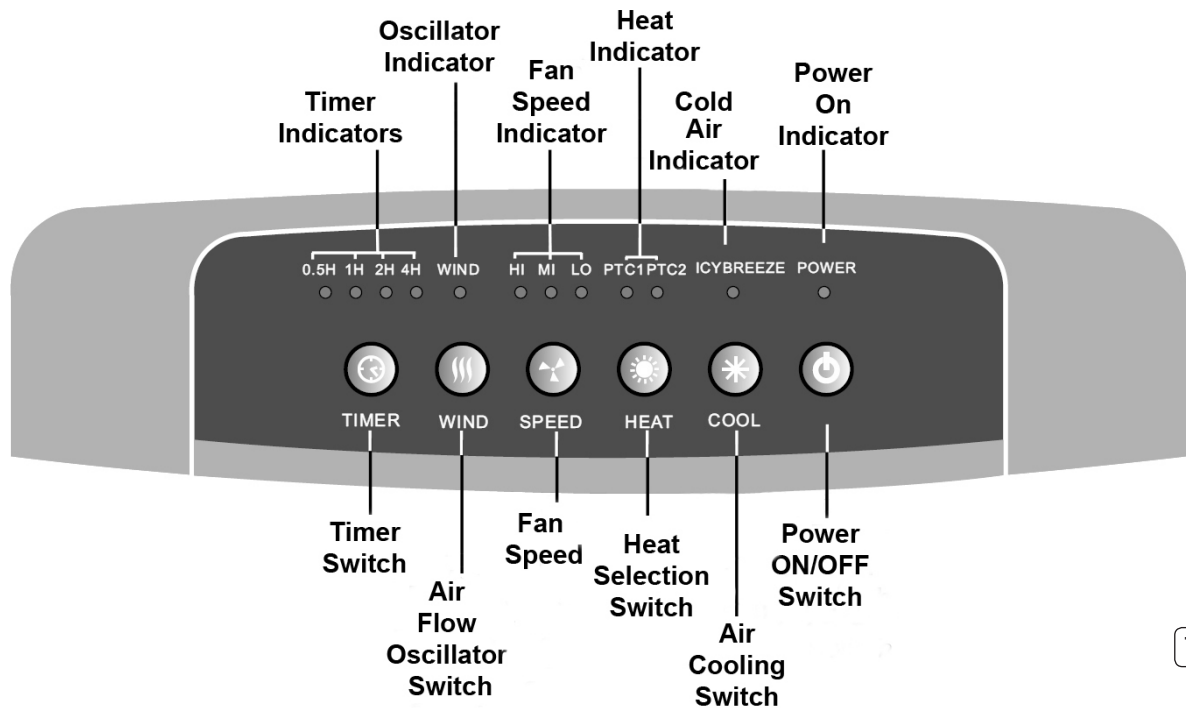

fig.2

3.2. Preparing the unit for cooling

- 3.2.1. The unit produces a cooling effect by evaporating water which is contained in a tank in the base of the unit. Before using as a cooler, the water tank must be filled. *Ensure that the unit is unplugged from the mains supply before topping up with water.* Open the water tank aperture on the side of the unit (fig.1), and pour water into the tank. Check the level of water in the tank through the water level sight at the front of the unit. The level should be between 'min' and 'max'. Close the cover. For an increased cooling effect, additionally place ice directly into the tank.
- 3.2.2. Plug the unit into the mains supply.
- 3.2.3. Switch the unit on by pressing the Power switch on the side of the unit.
- 3.2.4. Press the On/Off button on the control panel.

3.3. Using the unit for cooling

- 3.3.1. Make sure that the air flow control lever is moved to the COOL position.
- 3.3.2. Press the COOL button once to activate the cooling function. The 'Icy Breeze' indicator light above the button will illuminate. The fan will start to run at the speed last set.
- 3.3.3. Adjust the speed of the fan if required using the SPEED button.
- 3.3.4. Activate the louvre oscillation if required using the WIND button. Adjust the airflow up or down manually via the horizontal louvres.
- 3.3.5. Set the timer if required using the TIMER button.
- 3.3.6. To stop the cooling function press the COOL button again and the indicator light will go out.

3.4. Using the unit for heating

- 3.4.1. Make sure that the air flow control lever is moved to the HEAT position.
- 3.4.2. Press the HEAT button once or twice to select the required heating level. The indicator lights above will show the heating level selected. The fan will start to run at the speed last set.
- 3.4.3. Adjust the fan speed if required using the SPEED button. **NOTE:** Only two fan speeds are available: Medium and Low.
- 3.4.4. Activate the louvre side oscillation if required using the WIND button. Adjust the air flow up or down manually via the horizontal louvres.
- 3.4.5. Set the timer if required using the TIMER button.
- 3.4.6. To stop the heating function press the HEAT button until the indicator lights go out.
- 3.4.7. When the unit is switched OFF, using the ON/OFF button, the fan will continue to run for about 30 seconds. During this time the power light will flash until the unit shuts down.

3.5. Using the unit to humidify

- 3.5.1. In a dry and warm atmosphere the cooling action of the unit naturally adds humidity to the air due to the fact that the cooling action is provided by the evaporation of water.

3.6. Using the unit to filter and purify

- 3.6.1. The air for both heating and cooling is drawn into the unit through an activated carbon filter and thus cleans the air of dust and other particles.
- 3.6.2. The unit also contains a negative ion generator which produces cleaner, fresher air and reduces airborne odours. The ion generator starts to work as soon as the unit is switched on and works in both heating and cooling modes.

3.7. Using the unit as a fan only

- 3.7.1. If neither heating or cooling is selected on the control panel the unit will act as a 3 speed fan. In this mode both the TIMER and WIND functions can be used.

3.8. Remote control operation

The remote control handset provides the same functionality as the main control panel on the unit.

Note: the Heat/Cool Air Flow Control Lever must still be moved manually on the unit.

- 3.8.1. Insert two AAA batteries into the compartment in the back of the handset, ensuring that they are correctly inserted.
- 3.8.2. Ensure that the unit is plugged into the mains supply.
- 3.8.3. Set the Warm/Cool Air Flow Control lever on the unit to the desired position.
- 3.8.4. Point the handset at the main control panel on the unit.
- 3.8.5. Turn the unit on by pressing the ON/OFF button on the handset, and then control from the handset as per the normal settings above.

Open or remove side cover to allow access to water tank. Fill with water (and ice if required)

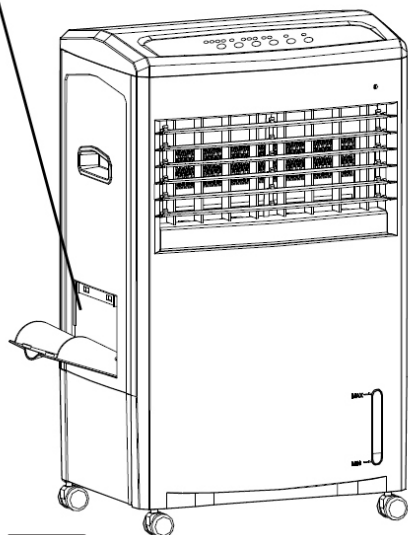

fig.3

Activated Carbon Filter
Filter Holder

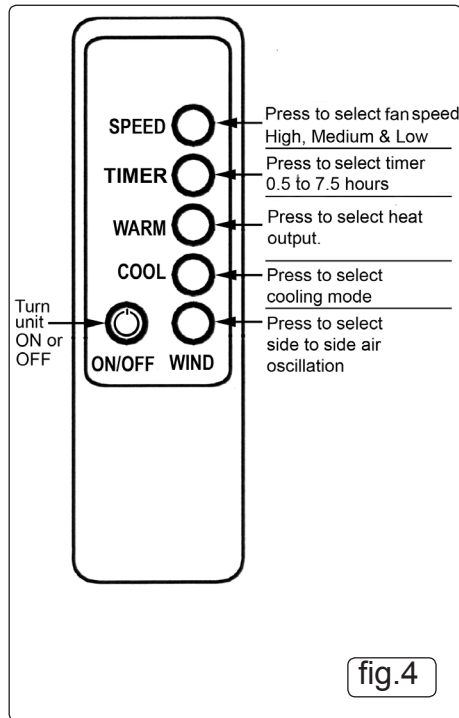
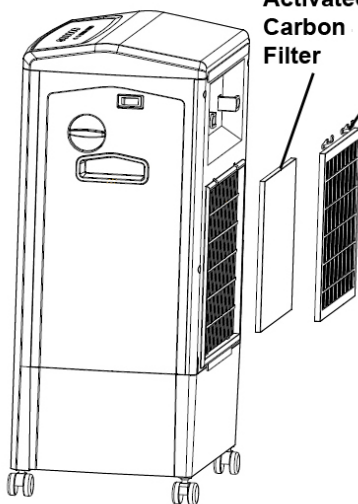

fig.4

4. MAINTENANCE

4.1. General Maintenance.

Turn the unit OFF and disconnect it from the mains power supply before cleaning or performing any maintenance.

4.1.1. Inspect the unit on a regular basis and replace or repair any damaged parts. *Use recommended parts and an authorised service agent. Unauthorised parts may be dangerous and will invalidate the warranty.*

4.1.2. Do not use any solvents or abrasive material to clean the plastic exterior of the unit. Use only a damp soft cloth for cleaning and dry the unit afterwards with a clean, dry, soft cloth.

4.2. **Air Filter.** Clean the air filter monthly for optimum performance. The filter is situated at the rear of the unit, and is held in place by a plastic frame.

4.2.1. Unclip the the top two retaining clips of the frame and pull the frame upwards and outwards to remove it. Remove the filter from the frame and tap it gently to remove dust, or vacuum it gently if it is very clogged with dirt. If the filter is heavily soiled, it can be washed in warm water containing a mild, neutral detergent. Ensure that the filter is completely dry before re-installing it.

4.2.2. To replace the filter, first insert the two bottom tags of the filter frame into the bottom edge of the filter frame recess in the unit. Lay the filter into the filter frame and hinge the frame forwards into the recess. Push the top of the frame inwards until the two clips snap into place.

4.3. If the unit is not to be used for a long period of time, drain off any water remaining in the tank. Place a large enough container under the rear of the unit, remove the rubber drainage stopper (fig.1) to allow the tank to drain. When the tank is empty, replace the stopper firmly. Clean the unit and air filter as above, and store in a safe, dry area, out of the reach of children.

Environmental Protection

Recycle unwanted materials instead of disposing of them as waste. All tools, accessories and packaging should be sorted, taken to a recycle centre and disposed of in a manner which is compatible with the environment.



When the product is no longer required, it must be disposed of in an environmentally protective way. Contact your local solid waste authority for recycling information.

Battery Removal



Remove the 2 AAA batteries from the remote control handset by sliding open the compartment door and unclipping them.

Dispose of batteries according to local authority guidelines.

WARNING: Do not dispose of by fire. This could result in an explosion.



Under the Waste Batteries and Accumulators Regulations 2009, Jack Sealey Ltd are required to inform potential purchasers of products containing batteries (as defined within these regulations), that they are registered with Valpak's registered compliance scheme.

Jack Sealey Ltd's Batteries Producer Registration Number (BPRN) is BPRN00705.

Parts support is available for this product. To obtain parts email sales@sealey.co.uk or phone 01284 757500.

NOTE: It is our policy to continually improve products and as such we reserve the right to alter data, specifications and component parts without prior notice.

IMPORTANT: No liability is accepted for incorrect use of this product.

WARRANTY: Guarantee is 12 months from purchase date, proof of which will be required for any claim.

INFORMATION: For a copy of our latest catalogue and promotions call us on 01284 757525 and leave your full name and address, including postcode.



Sole UK Distributor, Sealey Group,
Kempson Way, Suffolk Business
Park, Bury St. Edmunds, Suffolk,
IP32 7AR

01284 757500

01284 703534



www.sealey.co.uk



sales@sealey.co.uk