

Thank you for purchasing a Sealey product. Manufactured to a high standard this product will, if used according to these instructions and properly maintained, give you years of trouble free performance.



IMPORTANT: PLEASE READ THESE INSTRUCTIONS CAREFULLY. NOTE THE SAFE OPERATIONAL REQUIREMENTS, WARNINGS & CAUTIONS. USE THE PRODUCT CORRECTLY AND WITH CARE FOR THE PURPOSE FOR WHICH IT IS INTENDED. FAILURE TO DO SO MAY CAUSE DAMAGE AND/OR PERSONAL INJURY AND WILL INVALIDATE THE WARRANTY. PLEASE KEEP INSTRUCTIONS SAFE FOR FUTURE USE.

Only fully trained and qualified persons should use this equipment. These instructions are not a substitute for user receiving full supervised training by a qualified person. It is important the user understands the applications, limitations and potential hazards of the product.

1. SAFETY INSTRUCTIONS

- ❑ **WARNING! Ensure Health & Safety, local authority and general workshop practice regulations are adhered to when using this equipment.**
- ✓ Familiarise yourself with product application and limitations, as well as the specific potential hazards peculiar to the repair kit.
- ❑ **WARNING! No part of this unit or any accessory relating to the repair kit is designed for lifting loads. It is intended only as a pushing device and must be used as such, with care.**
- ❑ **WARNING! Disconnect the repair kit from the hydraulic pump before servicing or performing any maintenance on the unit.**
- ✓ Maintain repair kit in good order. Replace/repair with *genuine parts only*. *Non-genuine parts may be dangerous and will invalidate the warranty.*
- ✓ Use qualified person to lubricate and maintain the hydraulic pump. DO NOT use brake fluid to top up hydraulic unit. Use Sealey hydraulic oil only.
- ✓ Keep the repair kit clean for best and safest performance.
- ❑ **WARNING! Ensure you know how much load you are pushing. Never exceed the maximum pushing capacity.**
- ✓ Use only with the supplied Sealey hydraulic pump and accessories. Wrong equipment may damage unit and invalidate your warranty.
- ✓ The kit accessories may be used with other popular makes of kit.
- ✓ Ensure there is positive engagement of repair kit accessories to the vehicle body before pushing.
- ✓ Maintain correct balance and footing. Ensure the floor is not slippery and wear non-slip shoes.
- ✓ If working on an 'off centre' load, pump with care. If you feel undue resistance, stop and re-adjust the set-up.
- ❑ **WARNING! Keep your hands, body and clothing away from the repair kit and accessories when in use. Take any necessary precautions to protect your personal safety whilst using the repair kit.**
- ✓ Ensure the hydraulic hose is not bent or kinked but laid out correctly.
- ✓ Keep non-essential persons away from the operating area. Be aware of the locations of other persons assisting you.
- ✓ When releasing tension from the load be sure to undo the hydraulic valve VERY slowly.
- x **DO NOT** operate the repair kit if any parts are damaged or missing as this may cause failure and/or personal injury.
- ❑ **WARNING! DO NOT use repair kit as a lifting device of any type. DO NOT use for any purpose other than for which it is designed.**
- x **DO NOT** over extend the ram as the plunger may be forced out of the ram end.
- x **DO NOT** heat accessories as this may weaken them.
- x **DO NOT** modify accessories for use with this kit.
- ✓ When not in use, place dust cap in end of hydraulic hose and store the kit, in the case, in a safe, dry, childproof location.

2. CONTENT

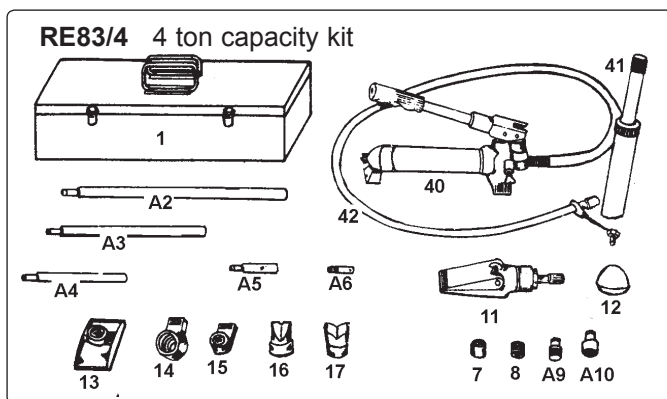

ITEM	PART NO.	DESCRIPTION
1	604/1	METAL BOX
A2	604/A2	21" SUPERSNAP® TUBING
A3	604/A3	18" SUPERSNAP® TUBING
A4	604/A4	10" SUPERSNAP® TUBING
A5	604/A5	6-1/2" SUPERSNAP® TUBING
A6	604/A6	3-1/4" TUBE ADAPTOR
7	604/7	SERRATED SADDLE
8	604/8	MALE CONNECTOR
A9	604/A9	MALE ADAPTOR
A10	604/A10	FEMALE ADAPTOR
11	604/11	SPREADER RAM
12	604/12	2-3/4" RUBBER HEAD
13	604/13	FLAT BASE
14	604/14	SPREADER RAM TOE
15	604/15	SPREADER PLUNGER TOE
16	604/16	WEDGE HEAD
17	604/17	90° V-BASE
40	604/40	10 TON HYDRAULIC UNIT
41	604/41	RAM
42	604/42	HOSE

3. INTRODUCTION

Kits feature snap together pipe work for speed and threaded attachments for strength. Connecting parts are zinc or cad plated for long, rust-free life. Components are manufactured from high quality steel and finished with red supergloss paint.

IMPORTANT:

Only fully trained and qualified persons should use this equipment. It is very important that the user understands the applications, limitations and specific potential hazards of the product.

VEHICLE DAMAGE INTRODUCTION

Before using the repair kit, you must determine the extent of vehicle damage. The technician will check all parts and determine if there is any broken, torn, crumpled, wrinkled, crushed, twisted or bent metallic parts. Measurements should be taken to see how far out of alignment the vehicle may be. It is important to determine correct dimensions by referring to the manufacturer's frame dimension charts and specifications. Remember, do not commence pushing until you are sure when to stop. Take time to examine and determine damage correctly. Comprehensive planning will save you time when you are actually using this equipment.

4. ATTACHMENTS

IMPORTANT: Only fully qualified personnel should attempt maintenance or repair to the hydraulic system.

4.1 Hydraulic Ram

(Item 41) For use in large spaces and where a large amount of force is required. Supplied with several attachments.

4.2 Extension Bars

(Items A2, A3, A4, A5) Plug into the hydraulic ram in different combinations in order to obtain the required length.

4.3 Serrated Saddle

(Item 7) Typically used on the pushing end in frame repair. Suitable for attachment to either end of the hydraulic ram or extension bars.

4.4 Rubber Head

(Item 12) This is used for popping dents out of doors and/or body panels. Suitable for attachment to either end of the hydraulic ram or extension bars.

4.5 Flat Base

(Item 13) This is used on the stationary side to spread the force of the hydraulic ram. Suitable for attachment to either end of the hydraulic ram or extension bars.

4.6 Spreader Ram Toe and Spreader Plunger Toe

(Items 14, 15) Typically used for straightening the edges of metal e.g. bumpers. Suitable for attachment to either end of the hydraulic ram or extension bars.

4.7 90° V Base

(Item 17) This is used to offset the force of the hydraulic ram when there is no straight line between the stationary and damaged sides. Suitable for attachment to either end of the hydraulic ram or extension bars.

4.8 Spreading Ram

(Item 11) This is used to repair minor dents and damage located in angles and tight spaces. Attaches directly to the pump unit.

4.9 Male Connector

(Item 8) This is used with the extension bars and other attachments that may be connected to the hydraulic ram. Plugs into the female end of the hydraulic ram.

When positioning the hydraulic ram, it is necessary wherever possible to use a smaller attachment on the side that is to be bent/reshaped. To further reduce the danger of the stationary side being damaged, place a block of wood or other suitable material (e.g. dense rubber) behind the base plate, in order to cushion the stationary side and spread the pressure exerted by the hydraulic ram.

4. ASSEMBLY

5.1 Unscrew the end plugs from the hose and hydraulic ram. Retain end caps for use when storing the kit.

5.2 Screw the hose into the hydraulic ram. Ensure the hose is secure but DO NOT overtighten.

5.3 Fit the pump handle to the pump unit - DO NOT overtighten.

To provide maximum versatility a combination of pump accessories may be used.

5.4 To use the rubber head, base plate and extension bars with the hydraulic ram, see fig 1.

To provide maximum versatility a combination of pump accessories may be used.

Illustrated below are the main attachment variations

Ensure the task you are undertaking falls within the capacity of the pump and accessories you are using.

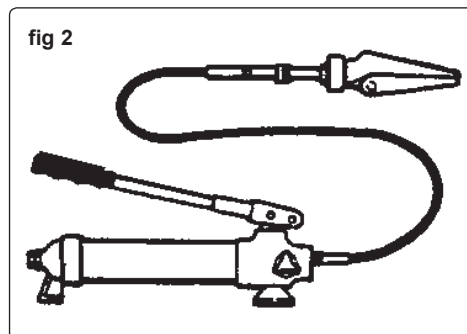
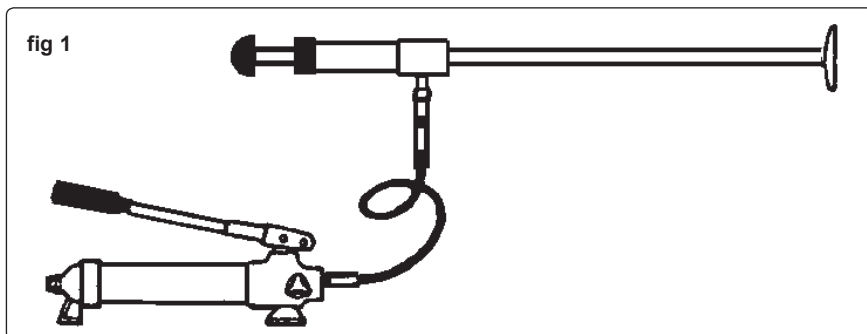

5.5 Four other common combinations are illustrated below

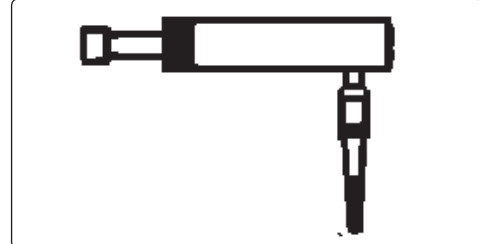
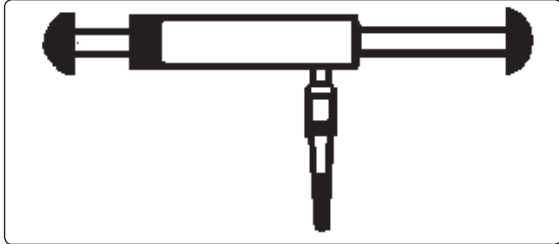
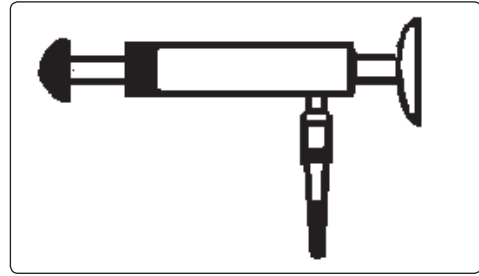
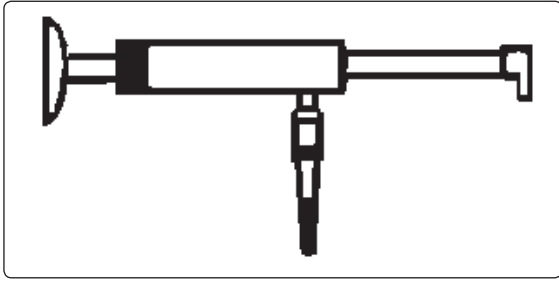

4. INSTRUCTIONS

❑ **WARNING!** Ensure you have read and understood chapter 1 safety instructions.

Note: These instructions are intended to provide a guide to the basic operation of the body repair kit and are in no way intended to replace the advice/instruction of a qualified mechanic/car body repair specialist. Only fully trained persons should use this equipment.

6.1 The pump may be used in any position from horizontal to vertical. When not horizontal ensure the hose end of the pump is down.

6.2 To use the pump, close valve (fig 3.A) by turning the knob clockwise and pump the the handle up and down to apply the load.

6.3 To release pump pressure, turn knob anti-clockwise (B).

6.4 REPAIRING FRAME DAMAGE

6.4.1 Determine the direction in which the frame needs to be bent.

6.4.2 Carefully remove any obstructions and items that may be damaged in the bending process.

6.4.3 Attach the base plate to the stationary side of the hydraulic ram.

6.4.4 Attach the appropriate attachment/combination of attachments to the pushing end of the hydraulic ram.

6.4.5 Position the assembled kit appropriately i.e. with the base plate resting against a frame member opposite the damaged area and in line with the direction in which the damaged area needs to be pushed.

6.4.6 Slowly extend the ram, being sure to direct the moving end of the ram toward the area in need of repair until contact is made.

6.4.7 Move as far away as possible and continue to slowly operate the pump, applying pressure until the desired bend has been made.

6.4.8 When operation is complete, slowly turn the release valve anti-clockwise. Remove the hydraulic ram.

6.5 REPAIRING BODY DAMAGE

6.5.1 Determine the direction in which the body panel needs to be moved.

6.5.2 Carefully remove any obstructions and items that may be damaged in the bending process.

6.5.3 Attach the base plate to the stationary side of the hydraulic ram.

6.5.4 Attach the appropriate attachment/combination of attachments to the pushing end of the hydraulic ram.

6.5.5 Position the assembled kit appropriately i.e. with the base plate resting against a frame/robust body part opposite the damaged area and in line with the direction in which the damaged area needs to be pushed. Be sure that the stationary frame/body part is stronger than the area to be bent (a block of wood or rubber may be used to protect the stationary part).

6.5.6 Slowly extend the ram, being sure to direct the moving end toward the area in need of repair until contact is made.

6.5.7 Move as far away as possible and continue to slowly operate the pump, applying pressure until the desired bend has been made.

6.5.8 When operation is complete, slowly turn the release valve anti-clockwise. Remove the hydraulic ram.

6.6 USING THE SPREADER RAM

6.6.1 Determine the direction in which the body panel needs to be moved.

6.6.2 Carefully remove any obstructions and items that may be damaged in the bending process.

6.6.3 Place the spreader ram such that the hinged arm is resting against the part to be moved and the stationary arm is resting against a strong fixed base. Holding the spreader ram in position, operate the pump until contact is made.

6.6.4 Move as far away as possible and continue to slowly operate the pump, applying pressure until the desired bend has been made.

6.6.5 When operation is complete, slowly turn the release valve anti-clockwise. Remove the spreader ram.

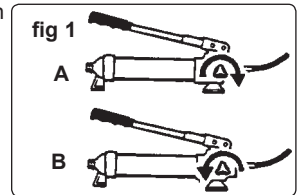

IMPORTANT: Always store the ram with the piston fully retracted to help prevent corrosion. Rams with signs of rust on the main piston cannot be replaced under warranty.

Rams with signs of damage to the piston or the cylinder and/or with damaged hydraulic couplings cannot be accepted under warranty.

Due to the severe abuse required to cause damage to the pump piston or arm hinge mechanism, these can not be accepted under warranty.

5. MAINTENANCE

IMPORTANT: Only fully qualified personnel should attempt maintenance or repair to the hydraulic system.

5.1. Pump oil level

Release pressure and disconnect the ram from the pump.

Hold pump in an upright position.

Remove filler plug and add hydraulic oil until it is level with the full mark (fig 2).

WARNING: DO NOT use brake fluid, or any fluid other than hydraulic jack fluid, as this may cause serious damage to the pump/ram and will invalidate the warranty! Use only Sealey hydraulic oil.

5.2. General

Before each use check for broken, cracked, bent, or loose parts, or any visible damage to welds, ram, pump, hose and accessories.

If any suspect item is found remove from service and take necessary action to remedy the problem.

Replace/repair with *genuine parts only*. *Non-genuine parts may be dangerous and will invalidate the warranty.*

Keep all parts of the kit clean. use only a mild detergent and a damp cloth. DO NOT use solvents.

Note: A small amount of oil around ram seal is normal - a thicker layer of oil may be deposited onto the ram initially, due to the ram seals bedding in.

Hydraulic couplings will weep a small amount of oil, particularly if ram is under pressure when coupling is released - this is normal. fig 4

fig 4



IMPORTANT: NO RESPONSIBILITY IS ACCEPTED FOR INCORRECT USE OF THE PUMP AND/OR RAM.

Hydraulic products are only repaired by local service agents. We have service/repair agents in all parts of the UK.

DO NOT RETURN PUMP OR RAM TO US. Please telephone us on 01284 757500 to obtain the address and 'phone number of your local agent. If product is under guarantee please contact your dealer.

De-commissioning Hydraulic Pump/Ram

Should the pump or ram become completely unserviceable draw off the oil into an approved container and dispose of the product and the oil according to local regulations.

NOTE: It is our policy to continually improve products and as such we reserve the right to alter data, specifications and component parts without prior notice.

IMPORTANT: No liability is accepted for incorrect use of this product.

WARRANTY: Guarantee is 12 months from purchase date, proof of which will be required for any claim.

INFORMATION: For a copy of our latest catalogue and promotions call us on 01284 757525 and leave your full name and address, including postcode.



Sole UK Distributor, Sealey Group,
Kempson Way, Suffolk Business Park,
Bury St. Edmunds, Suffolk,
IP32 7AR



01284 757500



www.sealey.co.uk



01284 703534



sales@sealey.co.uk