

Thank you for purchasing a Sealey product. Manufactured to a high standard this product will, if used according to these instructions and properly maintained, give you years of trouble free performance.



IMPORTANT: PLEASE READ THESE INSTRUCTIONS CAREFULLY. NOTE THE SAFE OPERATIONAL REQUIREMENTS, WARNINGS, AND CAUTIONS. USE THIS PRODUCT CORRECTLY AND WITH CARE FOR THE PURPOSE FOR WHICH IT IS INTENDED. FAILURE TO DO SO MAY CAUSE DAMAGE AND/OR PERSONAL INJURY AND WILL INVALIDATE THE WARRANTY. PLEASE KEEP INSTRUCTIONS SAFE FOR FUTURE USE.

1. SAFETY INSTRUCTIONS

1.1 ELECTRICAL SAFETY

WARNING! It is the responsibility of the owner and the operator to read, understand and comply with the following:

You must check all electrical products, before use, to ensure that they are safe. You must inspect power cables, plugs, sockets and any other connectors for wear or damage. You must ensure that the risk of electric shock is minimised by the installation of appropriate safety devices. A Residual Current Circuit Breaker (RCCB) should be incorporated in the main distribution board. We also recommend that a Residual Current Device (RCD) is used. It is particularly important to use an RCD with portable products that are plugged into a supply which is not protected by an RCCB. If in any doubt consult a qualified electrician. You may obtain a Residual Current Device by contacting your Sealey dealer.

You must also read and understand the following instructions concerning electrical safety.

- 1.1.1 The **Electricity at Work Act 1989** requires that all portable electrical appliances, if used on business premises, are tested by a qualified electrician, using a Portable Appliance Tester (PAT), at least once a year.
- 1.1.2 The **Health & Safety at Work Act 1974** makes owners of electrical appliances responsible for the safe condition of those appliances and the safety of the appliance operators. **If in any doubt about electrical safety, contact a qualified electrician.**
- 1.1.3 Ensure that the insulation on all cables and on the appliance is safe before connecting it to the power supply. See 1.1.1. and 1.1.2. and use a Portable Appliance Tester.
- 1.1.4 Ensure that cables are always protected against short circuit and overload.
- 1.1.5 Regularly inspect power supply cables and plugs for wear or damage and check all connections to ensure that none are loose.
- 1.1.6 **Important:** Ensure that the voltage marked on the appliance matches the power supply to be used and that the plug is fitted with the correct fuse - see fuse rating at right.

1.1.7 **DO NOT** pull or carry the appliance by the power cable.

1.1.8 **DO NOT** pull the plug from the socket by the cable.

1.1.9 **DO NOT** use worn or damaged cables, plugs or connectors. Immediately have any faulty item repaired or replaced by a qualified electrician. When a BS 1363/A UK 3 pin plug is damaged, cut the cable just above the plug and **dispose of the plug safely.** Fit a new plug according to the following instructions (UK only).

- a) **Connect the GREEN/YELLOW earth wire to the earth terminal 'E'.**
- b) **Connect the BROWN live wire to the live terminal 'L'.**
- c) **Connect the BLUE neutral wire to the neutral terminal 'N'.**
- d) **After wiring, check that there are no bare wires, that all wires have been correctly connected, that the cable outer insulation extends beyond the cable restraint and that the restraint is tight.**

Double insulated products, which are always marked with this symbol , are fitted with live (brown) and neutral (blue) wires only. To rewire, connect the wires as indicated above - **DO NOT** connect either wire to the earth terminal.

1.1.10 Products which require more than 13 amps are supplied without a plug. In this case you must contact a qualified electrician to ensure that a suitably rated supply is available. We recommend that you discuss the installation of an industrial round pin plug and socket with your electrician.

1.1.11 If an extension reel is used it should be fully unwound before connection. A reel with an RCD fitted is preferred since any appliance plugged into it will be protected. The cable core section is important and should be at least 1.5mm² but to be absolutely sure that the capacity of the reel is suitable for this product and for others which may be used in the other output sockets, we recommend the use of 2.5mm² section cable.

1.2 GENERAL SAFETY

- ✓ Disconnect the cleaner from the power supply before servicing, changing accessories, or performing any maintenance.
- ✓ Use only genuine parts and accessories. Unauthorised parts and accessories may be dangerous and will invalidate your warranty.
- ✓ Maintain the cleaner in good condition. Use an authorised agent for servicing. Keep machine clean, but **DO NOT** use solvents.
- ✓ For dry vacuuming ensure the cartridge filter is firmly in place before operating the cleaner.
- x **DO NOT** operate the unit without the cartridge filter in place (except when wet vacuuming). **Using the cleaner without a cartridge filter will cause machine faults and will invalidate your warranty.**
- ✓ Wear protective clothing and gloves.
- x **DO NOT** allow children or untrained persons to operate the cleaner.
- x **DO NOT** place attachments close to your face (especially eyes, ears, etc). **DO NOT** point the hose end at other persons or animals.
- ▲ **DANGER!** **DO NOT** vacuum hot or glowing ash, cigarette ends, inflammable, explosive, corrosive or other dangerous substances.
- x **DO NOT** operate the unit without the dust bag or optional cartridge filter (except when wet vacuuming).
- x **DO NOT** leave machine running unattended. Turn power supply OFF, and **DO NOT** leave the vicinity until motor has come to a complete stop.
- x **DO NOT** operate the cleaner while under the influence of drugs, alcohol or impairing medication, or if you are tired.
- x **DO NOT** use the cleaner in the rain or in very damp conditions.
- x **DO NOT** use the cleaner for a task it is not designed to perform.
- ✓ When not in use, store the cleaner in a safe, dry, childproof location.

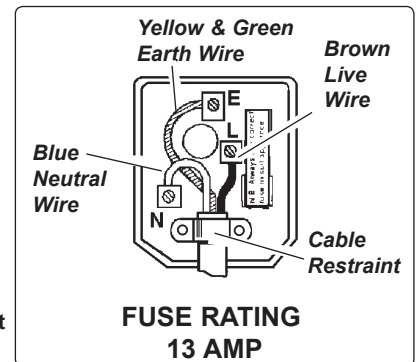

2. CONTENTS AND SPECIFICATIONS

High powered, lightweight unit with blower facility. Constructed from high impact plastic, the drum unit is mounted on four castors. Tool stowage points on head and base. Supplied with 4mtr cable with 3-pin plug, tool kit, cartridge filter and wet-use foam filter.

2.1 Carton content

- 2.1.1 Carefully unpack the carton.
- 2.1.2 Locate the two side clasps (fig.1.6) which hold the top section (fig.1.3) in place.
- 2.1.3 Undo the clasps, remove the top section and take out the items in the container.
- 2.1.4 Check and identify each component as listed below. If anything is missing or damaged please contact your supplier immediately.

2.2 Specification

Motor:230V / 1400W
Max. Vacuum Pressure 140mbar
Air Flow120M ³ /h
Container30ltr
Weight 5kg
Vac Accessories Ø: 35mm
Filter (See Sect.9 'Consumables') - Dry: Cartridge Filter
Filter (See Sect.9 'Consumables') - Wet: Foam

Item	Description	Item	Description
1	Handle	11	Suction tube extensions
2	ON/OFF switch	12	Blow connection
3	Top section	13	Combination nozzle
4	Filter basket	14	Crevice nozzle
5	Safety float valve	15	Foam filter
6	Clasp	16	Cartridge filter
7	Container	17	Noise diffuser muffler
8	Vacuum hose connection		
9	Drain Plug		
10	Flexible vacuum hose		

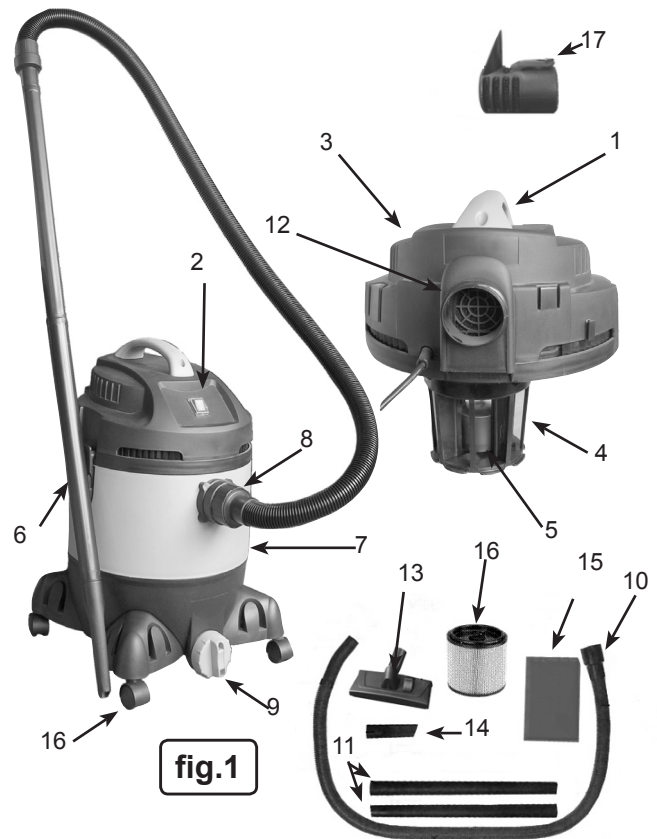

fig.1

3. ASSEMBLY

- 3.1 Ensure the mains plug is disconnected. (fig.2.1)
 - 3.2 Undo clasps. (fig.2.2)
 - 3.3 Lift off the top section assembly. (fig.2.3)
 - 3.4 Remove contents from inside the container. (fig.2.4)
 - 3.5 Turn the container upside down and insert the four feet with castors into the slots and apply pressure to ensure they lock into place and secure with the supplied screw. **DO NOT** overtighten screws. (fig.2.5)
 - 3.6 For dry vacuum cleaning use the cartridge filter supplied. (fig.2.6)
 - 3.7 For wet vacuum cleaning fit the supplied foam filter. (fig.2.7)
- NOTE: Do not operate the cleaner without a cartridge filter fitted as this will damage the machine and invalidate your warranty.**
- 3.8 Replace the top section onto the container. (fig.2.8)
 - 3.9 Align up the top section with the clasps and snap into place, by applying pressure at the mid point of the clasps. (fig.2.9)
 - 3.10 Attach the noise diffuser (fig.1.17) to the blow connection. (fig.1.12)
 - 3.11 Insert the large end of the hose into the front inlet of the container and lock in place by turning clockwise a quarter turn. (fig.2.10)
 - 3.12 Choose the desired extension tubes and nozzle and connect onto the hose (fig.2.11).

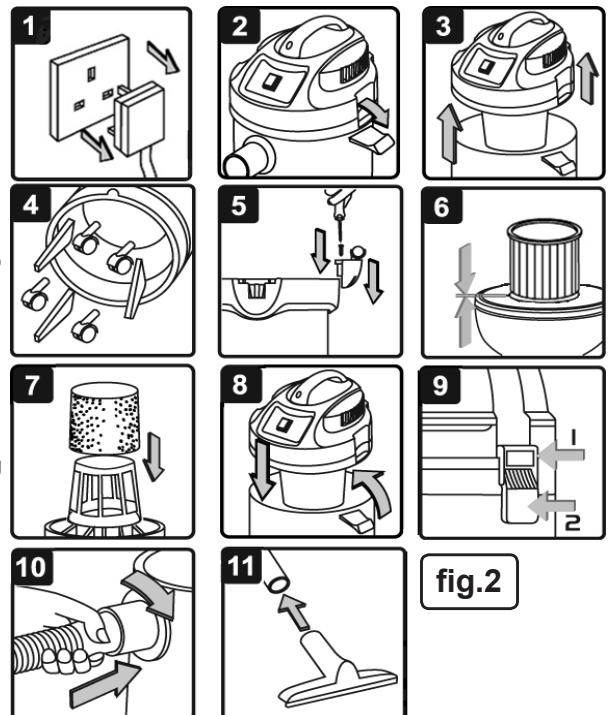

fig.2

4. DRY VACUUM CLEANING

WARNING! Ensure you read, understand and apply Section 1 'Safety Instructions'.

Reminder: DO NOT vacuum hazardous substances. Use of an incorrect cartridge filter will invalidate your warranty.

- 4.1 Ensure the machine is unplugged from the power supply. (fig.3.1)
- 4.2 Remove the top section and fit the cartridge filter down over the filter basket and push fully home. (fig.3.2)
- 4.3 Reposition the head onto the drum body, and clip in place. (fig.3.3)
- 4.4 Insert the larger end of the flexible hose into the front inlet on the container and lock in place. Push the required extensions and nozzle onto the flexible hose. (fig.3.4)
- 4.5 Plug in the power supply. (fig.3.5)
- 4.6 Switch to the 'On' (position 'I'). (fig.3.6)
- 4.7 When you have completed vacuuming, press the switch to 'Off'

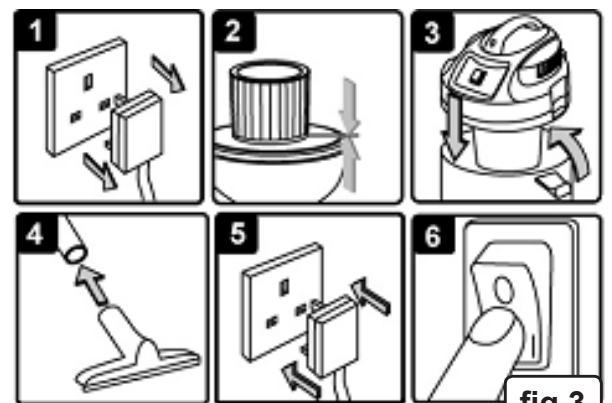

fig.3

5. WET VACUUM CLEANING

WARNING! Ensure you read, understand and apply Section 1 'Safety Instructions'. Reminder: Remove plug from power supply before opening unit. DO NOT vacuum solvents, explosives, inflammable and/or hazardous liquids such as petrol, oil, spirits, paint, thinners, acids etc.

- 5.1 Ensure the machine is unplugged from the power supply. (fig.4.1) Make sure the tank is clean and free from dust and dirt.
- 5.2 Remove the cartridge filter and fit a foam filter over the filter basket (fig.4.2). Replace the top section onto the container.
- 5.3 To the same flexible hose used in dry cleaning fit the desired nozzle (fig.4.3).
- 5.4 Ensure the switch is 'Off' (position '0') before plugging into the power supply.
- 5.5 Press the switch to 'On' (position 'I'). (fig.4.5)

Note: To vacuum large quantities of liquid, from a sink or tank etc, do not immerse the nozzle completely in the liquid, leave a gap at the top of the nozzle opening to allow an air inflow. The machine is fitted with a float valve which stops the suction action when the tank has reached its maximum capacity. The user will notice an increase in motor speed. When this happens, turn off the machine, disconnect from power supply, remove the head from the container and empty the liquid into a suitable receptacle or drain. (fig.4.6)

To continue vacuuming, refit the head and proceed. After wet vacuuming, turn the machine off and unplug from power supply. Empty the container and clean and dry the inside and outside before storage.

Remember! After wet vacuuming the foam filter must be removed and a cartridge filter must be fitted before dry vacuuming again.

- ❑ **WARNING! Not designed for liquid storage. Always empty liquids after use and before storing.**

6. BLOWING

- 6.1 Remove the noise diffuser and attach the large end of the flexible hose into the blow connection in the top section. (fig.5.1)
 - 6.2 Ensure the power switch is turned off (fig.5.2) and plug in the power supply. (fig.5.3)
 - 6.3 Switch on the power (position 'I'). (fig.5.4)
 - 6.4 The unit will now blow through the hose and can be used to clear obstructions within the pipe. (fig.5.5)
- ❑ **WARNING!** If after a few seconds the hose is still blocked turn off the unit and clear the hose manually.

7. MAINTENANCE

7.1 GENERAL MAINTENANCE.

- 7.1.1 Ensure the machine is unplugged from the power supply.
- 7.1.2 Disconnect the hose from the container.
- 7.1.3 Undo the clasps and remove motor head from the container.
- 7.1.4 Clear out any dirt or debris from the container and hose.
- 7.1.5 Clean the foam filter by washing it in a mild soapy solution.
- 7.1.6 Check that the telescopic suction tube operates smoothly and check the power cable to make sure it has not received any damage.

7.2 CARTRIDGE FILTER MAINTENANCE.

- 7.2.1 Handle the filter carefully when cleaning or installing.
- 7.2.2 Carefully remove the cartridge filter (fig.6.1) and inspect it for damage. A filter that has small holes or tears in it will not perform efficiently and should be replaced.
- 7.2.3 To clean a dry filter, tap it inside a waste bin. (fig.6.2)
- 7.2.4 Do not use the filter if it becomes wet as the filter will clog quickly and be very difficult to clean. (The cartridge filter is designed for dry vacuuming only). Should the filter be inadvertently wetted it should be rinsed from the inside (fig.6.2) and allowed to air dry for 24 hours.
- 7.2.5 To fit a new/cleaned filter slide it over the filter basket (fig.6.3) and push it fully home. (fig.6.4)

7.3 FOAM FILTER MAINTENANCE.

- 7.3.1 Remove the power head and position upside down, carefully remove the foam filter. (fig.7.1)
- 7.3.2 Use a mild soap and water solution to wash the foam filter and rinse with clean water. (fig.7.2)
- 7.3.3 Allow filter to air dry before installing and using again.

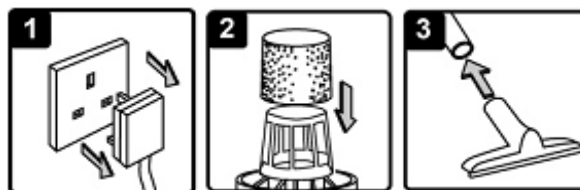

fig.4

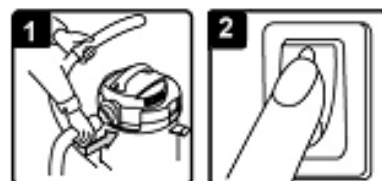

fig.5

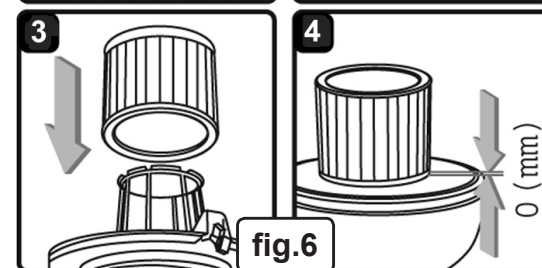

fig.6

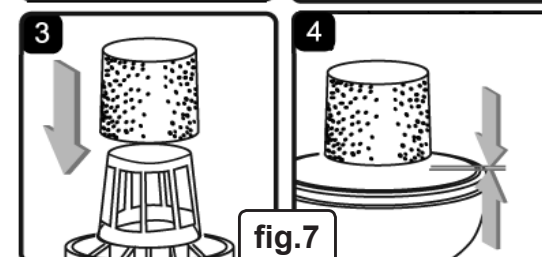

fig.7

8. TROUBLESHOOTING

Problem	Cause	Remedy
Cleaner will not operate.	No power supply. Faulty power cable, switch or motor. Container full of liquid.	Check supply. Check and repair or replace faulty item. Empty container.
Dust comes from the motor cover.	Cartridge filter missing or damaged.	Fit or replace cartridge filter.
Reduced efficiency and increased motor speed/vibration.	Dust container full. Filter clogged. Nozzle, hose or container inlet blocked.	Empty container. Clean or replace cartridge filter. Check nozzle, hose and container inlet for blockage.

9. CONSUMABLES

Cartridge Filter (Must be used for dry vacuuming) Model No. PC200CFL

Foam Filter (Pack of 10). Model No. PC200FF10

IMPORTANT! IF THE MACHINE IS USED WITHOUT A CARTRIDGE FILTER FITTED THE MOTOR WILL BURN OUT EVENTUALLY AND YOUR GUARANTEE WILL BE INVALIDATED. ALWAYS KEEP A SPARE CARTRIDGE FILTER HANDY.

PC300 Dust Bags (Pack of 5) Optional Extra Model No. PC300PB5

NOTE: It is our policy to continually improve products and as such we reserve the right to alter data, specifications and component parts without prior notice.

IMPORTANT: No liability is accepted for incorrect use of this product.

WARRANTY: Guarantee is 12 months from purchase date, proof of which will be required for any claim.

INFORMATION: For a copy of our latest catalogue and promotions call us on 01284 757525 and leave your full name and address, including postcode.



Sole UK Distributor, Sealey Group,
Kempson Way, Suffolk Business Park,
Bury St. Edmunds, Suffolk,
IP32 7AR



01284 757500



www.sealey.co.uk



01284 703534



sales@sealey.co.uk