

Thank you for purchasing a Sealey product. Manufactured to a high standard this product will, if used according to these instructions and properly maintained, give you years of trouble free performance.



**IMPORTANT: PLEASE READ THESE INSTRUCTIONS CAREFULLY. NOTE THE SAFE OPERATIONAL REQUIREMENTS, WARNINGS AND CAUTIONS. USE THIS PRODUCT CORRECTLY AND WITH CARE FOR THE PURPOSE FOR WHICH IT IS INTENDED. FAILURE TO DO SO MAY CAUSE DAMAGE AND/OR PERSONAL INJURY AND WILL INVALIDATE THE WARRANTY. PLEASE KEEP INSTRUCTIONS SAFE FOR FUTURE USE.**

### 1. SAFETY INSTRUCTIONS

- ✓ Familiarise yourself with the application, limitations and potential hazards peculiar to the spray gun.
- ❑ **WARNING!** Disconnect the spray gun from the air supply before changing accessories, servicing or performing any maintenance.
- ✓ Maintain the spray gun in good condition (use an authorised service agent).
- ✓ Replace or repair damaged parts. *Use recommended parts only. Unauthorised parts may be dangerous and will invalidate the warranty.*
- ✓ Keep the spray gun clean for best and safest performance.
- ✓ Ensure that the compressed air system can supply the spray gun air consumption- see specifications.
- ✓ Wear approved safety respiratory protection and safety eye goggles.
- ✓ If spraying isocyanate based finisher, wear approved respirator/clean air breathing apparatus and cover exposed skin with latex gloves and an impervious hooded coverall.
- ✓ Remove ill-fitting clothing. Remove ties, watches, rings and other loose jewellery and tie back long hair.
- ✓ Locate the spray gun in a suitable work area. Keep area clean and tidy and free from unrelated materials and ensure that there is adequate ventilation and lighting.
- ✓ Keep children and unauthorised persons away from the work area.
- ✓ When not in use, ensure that the air supply is turned off.
- ✓ Avoid unintentional operation of spray gun.
- x **DO NOT** point spray gun at yourself, other persons or animals.
- x **DO NOT** direct air from the air hose at yourself, other persons or animals.
- x **DO NOT** carry the spray gun by the hose, or yank the hose from the air supply.
- x **DO NOT** exceed the maximum air pressure of 29psi.
- x **DO NOT** use the spray gun for any purpose other than that for which it is designed.
- x **DO NOT** allow untrained persons to operate the spray gun.
- x **DO NOT** get the spray gun wet or use in damp or wet locations or in areas where there is condensation.
- x **DO NOT** operate the spray gun if any parts are missing or damaged as this may cause failure and/or personal injury.
- ✓ When not in use, disconnect the spray gun from the air supply, clean thoroughly and store safely.

### 2. INTRODUCTION & SPECIFICATION

Professional gravity feed spray gun set comprising a 1.0mm HVLP touch-up gun and a 1.3mm HVLP top-coat gun for larger coverage. Brass air cap with stainless steel needle and a nozzle suitable for water based paints. Fully polished body resists corrosion and makes for easy cleaning. Alternative set ups available separately.

Model No: .....	HVLP746 Top Coat .....	HVLP736 Touch Up
Standard set up:.....	1.3mm .....	1.0mm
Available set up:.....	1.7, 2.0mm .....	0.8mm
Air Pressure:.....	29psi .....	29psi
Air Consumption:.....	15cfm .....	9cfm
Pot Capacity: .....	600ml .....	125ml

### 3. AIR SUPPLY & CONNECTION

#### 3.1. Air Supply

- ❑ **WARNING!** Ensure the air supply is clean and does not exceed 29psi while operating the spray gun. Too high an air pressure and/or unclean air will shorten the product life due to excessive wear, and may be dangerous causing damage and/or personal injury.
- 3.1.1. Ensure spray gun air valve (or trigger) is in the off position before connecting to the air supply.
- 3.1.2. You will require an air pressure of 29psi, and an air flow according to specification.
- 3.1.3. Drain the air tank daily. Water in the air line will ruin the paint finish and damage the spray gun.
- 3.1.4. Clean air inlet filter weekly.
- 3.1.5. Line pressure should be increased to compensate for unusually long air hoses (over 8 metres). The minimum hose diameter should be 1/4" internal diameter and fittings must have compatible dimensions.
- 3.1.6. Keep hose away from heat, oil and sharp edges. Check hose for wear, and make certain that all connections are secure.

#### 3.2. Couplings

Vibration may cause failure if a quick change coupling is connected directly to the spray gun. To overcome this, connect a leader hose to the spray gun (Sealey ref: AH2R or AH2R/38). A quick change coupling may then be used to connect the leader hose to the air line recoil hose. See fig.1 & fig.2.

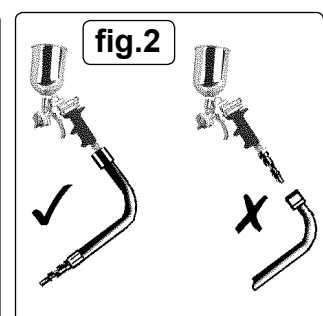
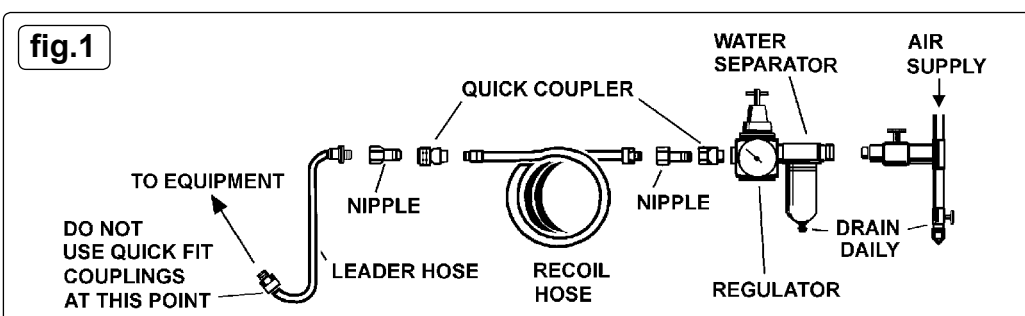

## 4. OPERATING INSTRUCTIONS

- 4.1. For best results, the gun should be held perpendicular to the surface being sprayed and moved parallel to it. Start the stroke before squeezing the trigger and release the trigger before finishing the stroke. This will enable you to accurately control the gun and material (fig.3).
- 4.2. Spray from a distance of about 150mm to 250mm depending on the material and the atomising pressure. The material deposited should always be even and wet. Each stroke must overlap the preceding stroke to obtain a uniform finish. To reduce over-spray and obtain maximum efficiency, spray with the lowest possible atomising air pressure.
- 4.3. Controlling the fan spray and the fluid.
  - a) Use the needle (paint) adjustment knob (fig.4.2) to increase or decrease the amount of paint flow.
  - b) The atomising air flow is controlled by knob (4.1). The volume of air input is controlled by knob (4.3).
  - c) As width of spray is increased more material must pass through the gun to obtain the same coverage on the increased area.
  - d) Turn the air nozzle (4.4) to achieve a horizontal or vertical fan spray. Lock the nozzle with retaining ring (4.5).
 The spray pattern of the gun is variable from round to flat with all patterns in between. In normal operation, the wings on the nozzle are horizontal. See fig.5. This provides a vertical fan-shaped pattern which gives maximum uniform and even coverage when moving the gun back and forth, parallel to the work surface.

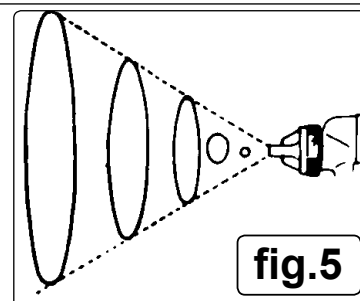
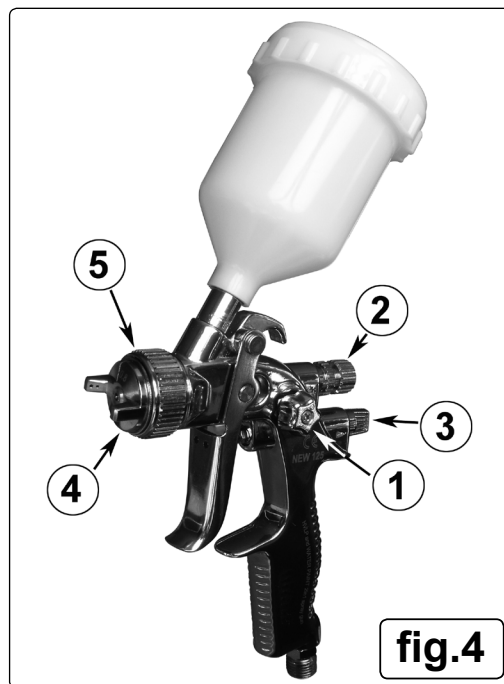
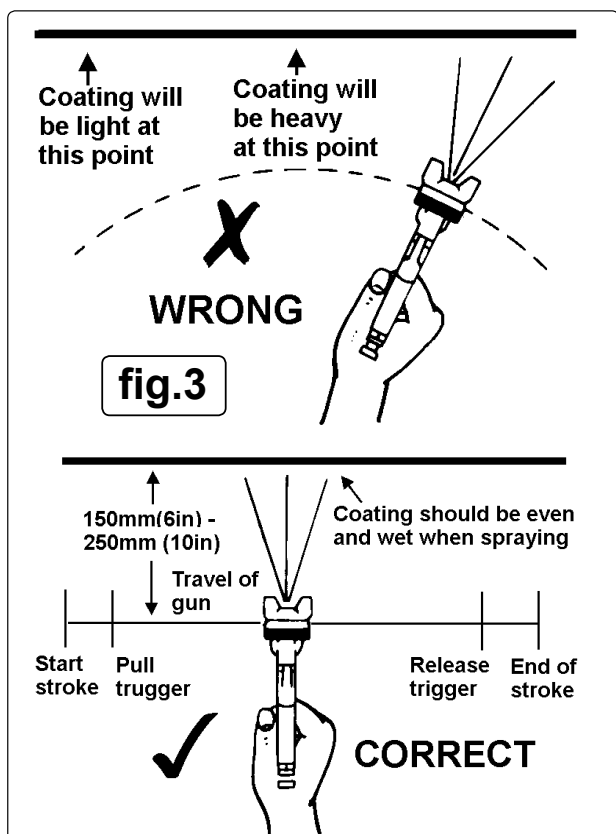

## 5. CLEANING & MAINTENANCE

**FOR OPTIMUM PERFORMANCE IT IS VERY IMPORTANT TO ENSURE THE GUN IS CORRECTLY CLEANED AFTER EACH USE.**

Disconnect from the air supply before attempting any cleaning or maintenance.

### 5.1. Cleaning the gun

- 5.1.1. Immerse the front end of the gun only in solvent. The solvent should just cover the fluid connection. (fig.6).
- 5.1.2. Use a bristle brush and solvent to wash off accumulated paint.
- 5.1.3. Do not immerse the entire gun in solvent as this will cause lubricants on the rubber seals to dissolve. Dirty solvent may also clog narrow passages in the gun.
- 5.1.4. Flush the gun through with clean solvent.
- 5.1.5. Wipe the outside of the gun with a dampened solvent rag.

### 5.2. Air nozzle, fluid nozzle and needle assembly

- 5.2.1. To clean the nozzles, soak them in solvent to dissolve any dried material then blow them clean with air. Handle all nozzles carefully and do not make any alterations in the gun.
- 5.2.2. If you need to probe the holes in the nozzles, be sure to use a tool that is softer than brass; do not use metal instruments.
- 5.2.3. Adjust the fluid needle valve so that when the gun is triggered, air flow occurs before fluid flow.

### 5.3. Maintenance

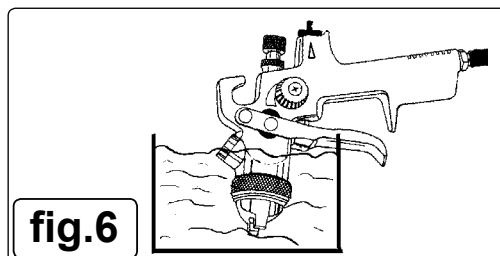

- 5.3.1. Disassemble using a suitable spanner.
- 5.3.2. Take care when re-assembling. Firstly screw parts hand tight to avoid cross-threading then tighten with spanner. If a part cannot easily be turned by hand, check that you have the correct part, or unscrew, realign and try again. DO NOT use excessive force when re-assembling.
- 5.3.3. Lubricate the gun daily with a light machine oil.
- 5.3.4. If you change the nozzle size, ensure the complete nozzle set is exchanged. Insert paint nozzle before putting the paint needle in.

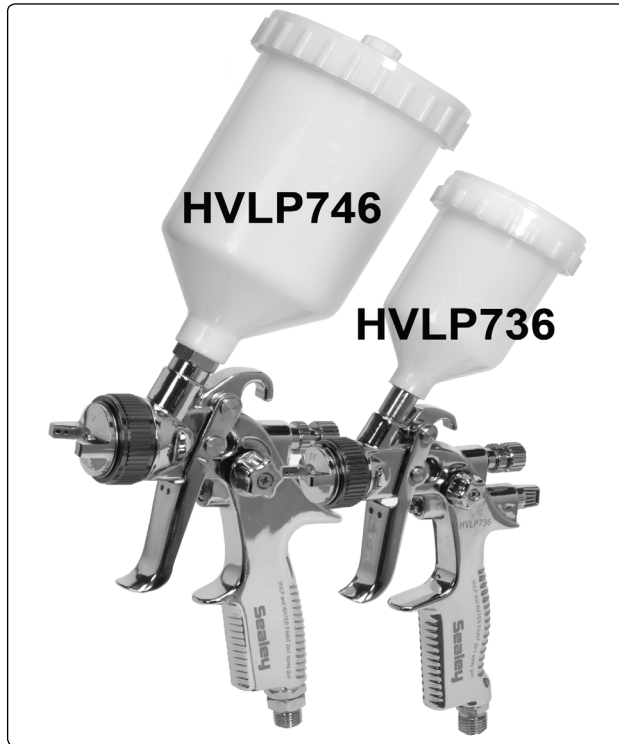

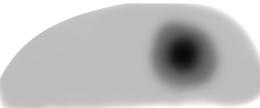

## 6. TROUBLESHOOTING

A faulty spray is usually caused by improper cleaning or dried material around the fluid nozzle tip or in the air nozzle. Soak these parts in a solvent that will soften the dried material and remove with a brush or a cloth. Never use metal instruments to clean the air or fluid nozzles. These parts are carefully machined and any damage will cause a faulty spray. If either the air nozzle or fluid nozzle is damaged, these parts must be replaced before a perfect spray can be achieved.





VIEW OF PROBLEM	POSSIBLE REASON FOR PROBLEM	SOLUTION
	Dried material in a dirty side port restricts passage of air. Greater flow of air from the cleaner side port forces a fan pattern in the direction of the clogged side.	Dissolve material in the side ports with solvent, then blow the gun clean. Do not poke into the opening with metal instruments.
	Dried material around the outside of the fluid nozzle tip restricts the passage of atomising air at one point through the centre opening of the air nozzle and results in the pattern shown. This pattern can also be caused by a loose air nozzle.	Remove the air nozzle and wipe off fluid tip using a rag dampened with solvent. Tighten the air nozzle.
	Material too thin or atomization air pressure too high.	Regulate material viscosity or reduce air pressure.
	Dirt between the fluid nozzle seat and body or loosely installed fluid nozzle will cause the gun to spit.	Remove the fluid nozzle, clean the back of the nozzle and the nozzle seat in the gun body using a rag dampened with thinner. Replace the nozzle and secure it tightly against the body.
Material bubbles or 'boils' in paint cup.	Atomised air flowing through the paint channel to pot. The paint nozzle is not tight enough. Air nozzle is not completely screwed in.	Tighten, clean or replace parts accordingly.

**NOTE:** It is our policy to continually improve products and as such we reserve the right to alter data, specifications and component parts without prior notice.

**IMPORTANT:** No liability is accepted for incorrect use of this product.

**WARRANTY:** Guarantee is 12 months from purchase date, proof of which will be required for any claim.

**INFORMATION:** For a copy of our latest catalogue and promotions call us on 01284 757525 and leave your full name and address, including postcode.

	<p>Sole UK Distributor, Sealey Group, Kempson Way, Suffolk Business Park, Bury St. Edmunds, Suffolk, IP32 7AR</p>	 01284 757500	 <a href="http://www.sealey.co.uk">www.sealey.co.uk</a>
		 01284 703534	 <a href="mailto:sales@sealey.co.uk">sales@sealey.co.uk</a>