

Thank you for purchasing a Sealey Product. Manufactured to a high standard this product will, if used according to these instructions and properly maintained, give you years of trouble free performance.



IMPORTANT
 PLEASE READ THESE INSTRUCTIONS CAREFULLY. NOTE THE SAFE OPERATIONAL REQUIREMENTS, WARNINGS AND CAUTIONS. USE THIS PRODUCT CORRECTLY AND WITH CARE FOR THE PURPOSE FOR WHICH IT IS INTENDED. FAILURE TO DO SO MAY CAUSE DAMAGE AND/OR PERSONAL INJURY AND WILL INVALIDATE THE WARRANTY. PLEASE KEEP INSTRUCTIONS SAFE FOR FUTURE USE.

1. SAFETY INSTRUCTIONS

1.1. GENERAL SAFETY

- WARNING!** Ensure Health & Safety, local authority, and general workshop practice regulations are adhered to when using this equipment.
- x **DO NOT** use the Beam Setter in direct sunlight.
- x **DO NOT** splash the Beam Setter with water or any other liquid.
- x **DO NOT** operate the Beam Setter if it is damaged.
- x **DO NOT** use the Beam Setter for purposes other than that for which it is designed.
- ✓ Avoid sudden changes in temperature.
- ✓ Avoid sudden vibration.
- ✓ Keep work area clean and tidy and free from unrelated materials.
- ✓ Ensure the vehicle handbrake is engaged
- ✓ Ensure there are no passengers in the vehicle.
- ✓ When not in use store Beam Setter in a safe, dry, childproof location.

2. SPECIFICATION

Ideal for the garage or bodyshop where space is limited. Suitable for pre-MOT inspection and fulfils the legal obligation of the garage or bodyshop to return vehicles to the customer in roadworthy condition. Compact design includes shortened mast and view through aiming device. Suitable for all types of cars, motorcycles and light commercial vehicles (Classes I, II, III, IV, V, VII).

Height: 1380mm

Width: 630mm

Length: 550mm

IMPORTANT: This Beam Setter uses a fixed graduated screen in accordance with the requirements of the MOT regulations. However it must be noted that the HBS2010.V2 is **NOT** approved by VOSA for conducting tests in accordance with MOT requirements.

3. ASSEMBLY

- A Base
- B Column
- C Release Lever
- D Light Box
- E Aligner
- F Retaining Handle

- 3.1. Attach the 3 wheels to the base (A) of the unit using long bolts (axles), washers and nuts.
- 3.2. Attach base of column (B) to base of unit, using four sets of bolts, washers and nuts. Column should be positioned so that two holes in top of column base are in line with wheels.
- 3.3. Position mid section into column base and fix in place using two countersunk headed allen bolts.
- 3.4. Slide the beam setting light box (D) over the top of the column, squeezing the release lever (C) first. Release the release lever to lock the light box onto the column.
- 3.5. Insert retaining handle (F) through top of column B, place a washer then the aligner (E) onto the threaded end and tighten.

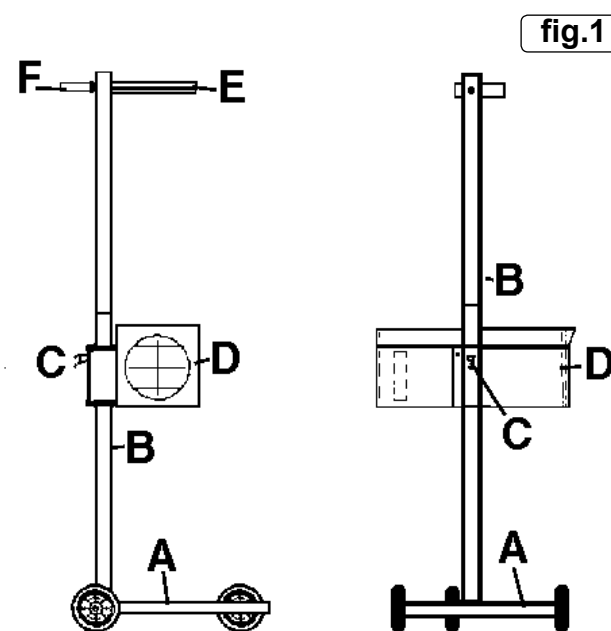

4. OPERATION

4.1. SET-UP

- 4.1.1. Position the vehicle on the designated headlamp aim standing area, when positioning the Beam Setter, ensure that the floor is even and level, if this is not possible the vehicle and Beam Setter **must** be on the same slope, which must not exceed 3.0°. Headlights must not be checked where surface angle exceeds 3.0° (fig.2).
- 4.1.2. Straighten the vehicle's wheels and check that the tyre pressures are correct.
- 4.1.3. Ensure the headlights are clean and dry.
- 4.1.4. If the vehicle is fitted with manual or electric headlamp levelling device, ensure that it is set for the vehicle with a normal load.
- 4.1.5. Remove anything which could alter the attitude of the vehicle, i.e. a heavy load in the boot.

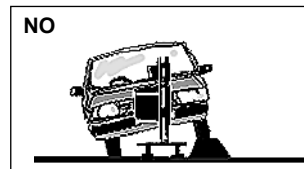
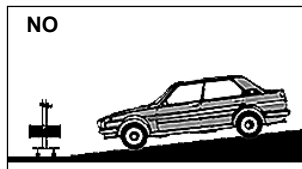
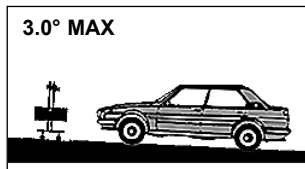
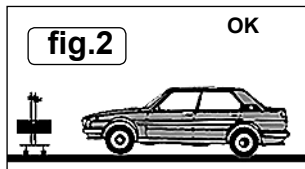

4.2. CHECKING BEAM SETTING

- 4.2.1. Position the Beam Setter approximately 200 to 500mm from one of the vehicle's headlamps.
- 4.2.2. Stand behind the Beam Setter and looking through the aligner, align with two symmetrical points on the vehicle i.e. the bonnet lip or the bottom of the windscreen.
- 4.2.3. Ensure the line is parallel with the horizontal, or symmetrical selection, by rotating the Beam Setter. This will ensure that it is square with the vehicle.
- 4.2.4. Measure the height of the centre of the headlamp from the floor.
- 4.2.5. Squeeze the release lever whilst supporting the light box and move the light box up or down the column as required until the centre of the lens is at the same height as the headlamp. Release the release lever.
- 4.2.6. Use the white central sighting line on top of the light box housing to align the Beam Setter with the centre of the headlamp.
- 4.2.7. If necessary, start the vehicle's engine so that the battery is not drained during the procedure.

Note: When checking headlamp aim on vehicles with hydropneumatic suspension systems, it is necessary to have the engine idling.
- 4.2.8. Switch the headlamps on to dip beam.
- 4.2.9. Determine the appropriate dip beam image and the aim (see figs.3 and 4). Headlamps of older vehicles (approx. pre 1950) may have beam images which do not conform. In such cases check:
 - a) **DIP BEAM** headlamps are aimed so that they do not dazzle, i.e. the brightest part of the beam image is aimed at least 0.5% below the horizontal (fig.5), or for headlamps which cannot be checked on dip beam, check:
 - b) **MAIN BEAM** headlamps are aimed so that the beam image centre is on or slightly below the horizontal (fig.5).

ASYMMETRICAL DIPPED BEAM

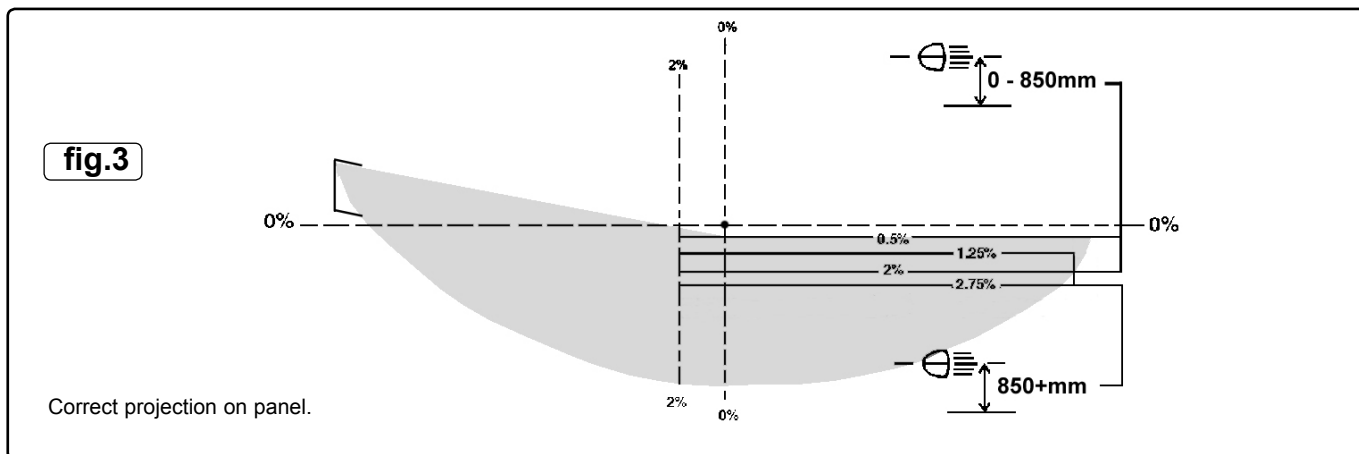

SYMMETRICAL DIPPED BEAM

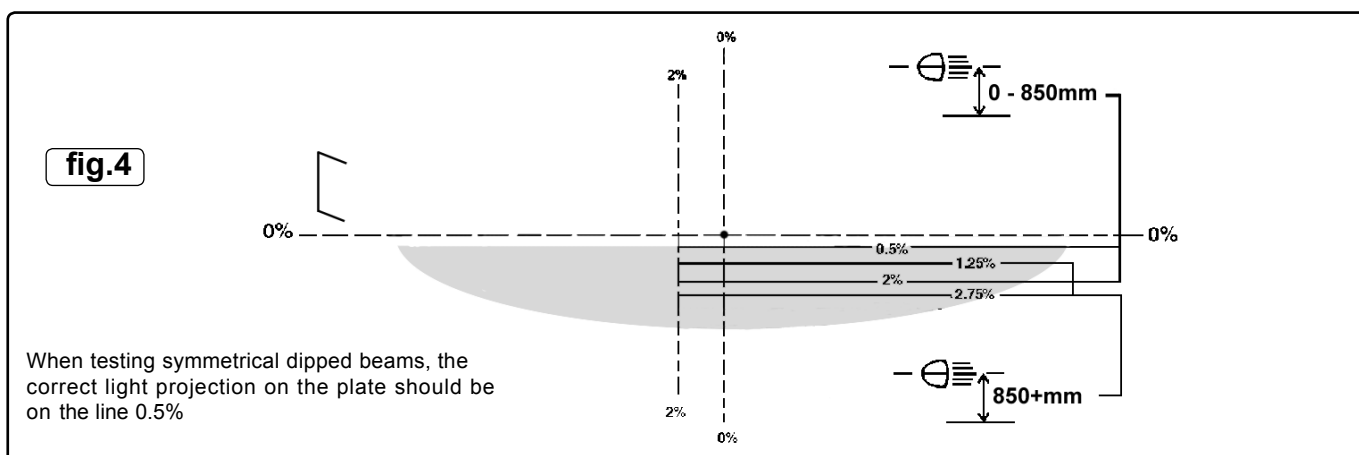

- 4.2.10. Check that the headlamp beam tolerances are in accordance with the MOT inspection manual and are within the operating tolerances specified by the manufacturer.
- 4.2.11. Adjust the headlight(s) until the required result is obtained.
- 4.2.12. When testing the more commonly used asymmetrical headlight (see fig.3), remember that the projection will light up a section on the LEFT hand side of the plate at an angle of about 15° above the horizontal plane. Just under the centre, on the left, a small zone will appear brighter than the rest of the projection.
- 4.2.13. Switch the headlamps on to main beam. They should be aimed so that the beam image centre is on the Zero position (fig.5). Adjust if necessary

MAIN BEAM

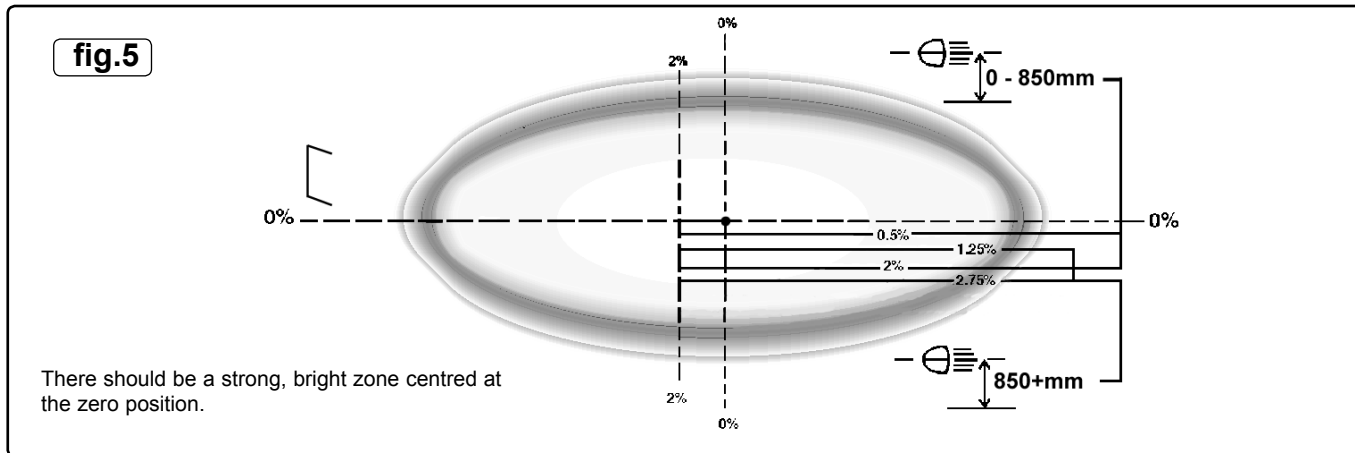

5. CALIBRATION

It is recommended that the unit has periodic calibration checks. The headlamp beam setter can be recalibrated using a laser alignment calibration unit. We recommend the Sealey AK9999 (available from your authorised Sealey dealer). Set up the laser calibration device and level it first, the beam setter can then be manoeuvred easily on it's stand with reference to the position of the laser. The laser can be placed on any surface such as a car bonnet, box, table etc of suitable height.

- 5.1. Using the calibrated spirit level within the laser alignment calibration device, ensure that the unit is flat and level.
- 5.2. Switch the laser on. Manoeuvre the beam setter in order to centre the laser beam in the beam setter lens. This must be done "by eye". There is a ±20mm tolerance on centralisation of the beam through the lens. The beam setter should be approximately 2m from the laser.
- 5.3. The three dots projected onto the aiming screen should bisect the 0° line, at the far left, centre and far right of the screen (fig.6). It is necessary at this point to rotate the column through the vertical axis, to track the beam from one side of the aiming screen to the other. Take care to ensure that the laser and the beam setter both remain level throughout.

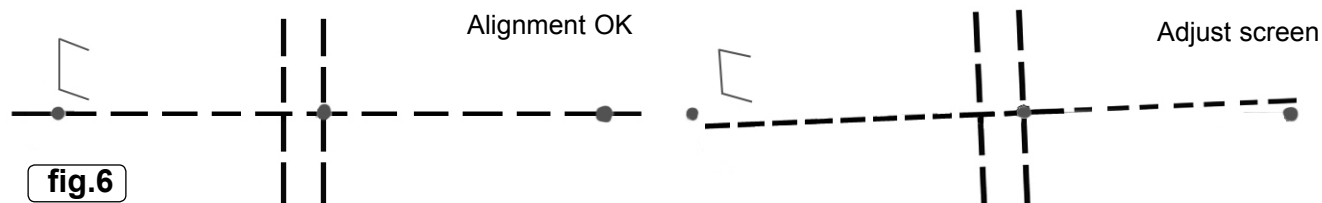

- 5.4. If it is necessary to adjust the screen, unscrew the two retaining screws holding the top clear cover in place and remove it.
- 5.5. Slightly loosen the two screws holding the screen in place, reposition the screen so that the projected laser dots correctly bisect the 0° line.
- 5.6. Retighten the screws, taking care not to move the screen out of position. Re-check to confirm it is still aligned correctly and then re-fit the top cover and two screws.

6. MAINTENANCE

- 6.1. Clean with a slightly dampened cloth, being especially careful with the lens so as not to damage it.
- 6.2. DO NOT leave the machine in areas where corrosive vapour is present, i.e. from battery charging or paint spraying etc.
- 6.3. DO NOT oil the column.
- 6.4. When not in use store Beam Setter in a safe, dry, childproof location.

Parts support is available for this product. To obtain a parts listing and/or diagram, please log on to www.sealey.co.uk, email sales@sealey.co.uk or phone 01284 757500.

NOTE: It is our policy to continually improve products and as such we reserve the right to alter data, specifications and component parts without prior notice.
IMPORTANT: No liability is accepted for incorrect use of this product.
WARRANTY: Guarantee is 12 months from purchase date, proof of which will be required for any claim.
INFORMATION: For a copy of our latest catalogue and promotions call us on 01284 757525 and leave your full name and address, including postcode.



Sole UK Distributor, Sealey Group,
 Kempson Way, Suffolk Business
 Park, Bury St. Edmunds, Suffolk,
 IP32 7AR

☎ 01284 757500

🌐 www.sealey.co.uk

📠 01284 703534

✉ sales@sealey.co.uk