



INSTRUCTIONS FOR: GEARED HAND WINCHES:

GWE1200M 540KG CAPACITY	GWC1200M WITH CABLE 540KG CAPACITY	GWW1200M WITH WEBBING 540KG CAPACITY	GWE2000M 900KG CAPACITY	GWC2000M WITH CABLE 900KG CAPACITY	GWW2000M WITH WEBBING 900KG CAPACITY
-----------------------------------	---	---	-----------------------------------	---	---

Thank you for purchasing a Sealey product. Manufactured to a high standard this product will, if used according to these instructions and properly maintained, give you years of trouble free performance.

⚠ IMPORTANT: PLEASE READ THESE INSTRUCTIONS CAREFULLY. NOTE THE SAFE OPERATIONAL REQUIREMENTS, WARNINGS & CAUTIONS. USE THE PRODUCT CORRECTLY AND WITH CARE FOR THE PURPOSE FOR WHICH IT IS INTENDED. FAILURE TO DO SO MAY CAUSE DAMAGE AND/OR PERSONAL INJURY AND WILL INVALIDATE THE WARRANTY. PLEASE KEEP INSTRUCTIONS SAFE FOR FUTURE USE.

1. SAFETY INSTRUCTIONS

- WARNING! Winch is not designed for lifting or slinging loads. It is intended only for pulling a load and must be used with care.**
- ✓ Fit only appropriately rated cable or strap and hook suitable for the task for which the winch is to be used.
- ✓ Ensure the winch is maintained in a safe working condition. Inspect the cable or strap regularly checking for fraying, kinks, broken strands or distortion. If such is present, replace. Check all component parts, do not use if damaged, contact authorised service agent.
- ✓ Most truck beds are not designed to support the pulling capacity of a winch. Choose an appropriately strong winching point, which we recommend is reinforced with steel plates and appropriate securing bolts. The winch mounting point must be capable of withstanding 4 x the maximum rated capacity of the winch.
- WARNING! Keep hands, your body and clothing away from the winch components and the cable or strap. Use a rag or protective gloves when handling cable. Take any necessary precautions to protect your personal safety whilst using the winch.**
- ✓ For a heavy load place a blanket (or jacket) over extended cable about 2 feet away from the hook in order to lessen the severity of a cable break.
- WARNING! Ensure you know how much load you are winching. Never exceed the maximum pulling capacity. Take into account any angle of incline over which the load must be pulled. Also account for winching loads from thick mud, or through snow or water. Check the wheels of vehicles to be winched then release any brakes and place gears in neutral, ensure the load is capable of free movement before winching. Take up the strain on the cable or strap and remove the wheel chocks to move the load.**
- ✓ Ensure the load to be pulled has an appropriate fixing point. If not, fit an adequate sling, eyebolt or other accessory to the load. Ensure accessories are equal to, or exceed, the maximum pulling capacity of the winch.
- ✓ Ensure cable or strap is securely attached to the load before winching.
- ✓ Maintain correct balance and footing whilst using the winch.
- ✓ Remove ill fitting clothing. Remove ties, watches, rings and other loose jewellery, and contain and/or tie back long hair.
- ✓ Keep children and non essential persons away from the operating area. Be aware of the location of other persons assisting you.
- ✓ Apply even and steady pressure to the handle when releasing the tension from the load.
- x **DO NOT** operate the winch if any parts are damaged or missing as this may cause failure and/or personal injury.
- WARNING! DO NOT use winch as a lifting device of any type. DO NOT use the winch for any purpose other than for which it is designed.**
- WARNING! DO NOT exceed the rated pulling capacity of the winch.**
- x **DO NOT** pull the cable or strap over or around a corner and **DO NOT** take the hook around the load and hook back onto the cable. Use appropriate sling if necessary.
- x **DO NOT** operate the winch with less than FIVE wraps of cable or strap on the drum.
- ▲ **DANGER! DO NOT use any "cheater" pipe, lever, or other device to lengthen the handle for additional leverage, as the pulley may fail causing damage and possible personal injury. If the winch can not be operated by hand, it may be overloaded.**
- x **DO NOT** operate the winch if you are tired or under the influence of alcohol, drugs or intoxicating medication.
- WARNING! AVOID SIDEWAYS CABLE SLIP**
The cable under load should only be wound on to the drum to such an extent that a minimum space of two times the cable diameter remains on the drum flange. Winch overloading and a sideways cable slip will therefore be avoided.
- WARNING! The warnings, cautions and instructions discussed in this manual cannot cover all possible conditions and situations that may occur. It must be understood that common sense and caution are factors which cannot be built into this product, but must be applied by the operator.**

2. INTRODUCTION & SPECIFICATION

Manufactured from hardened steel with a heavy plate chassis. Features a single geared mechanism for a smooth and easy operation. Includes a manual brake system, allowing the user to adjust the restriction placed on the webbing or cable. Suitable for general and recovery operations. Optional cable or webbing models available. Available with an empty drum, with cable or webbing and in two capacities.

Model No:	GWC1200M	GWE1200M	GWW1200M	GWC2000M	GWE2000B	GWW2000B
Capacity: 540kg 540kg 540kg 900kg 900kg 900kg
Gear Ratio: 4.1:1 4.1:1 4.1:1 4.1:1 4.1:1 4.1:1
Hub Diameter: 20mm 20mm 20mm 20mm 20mm 20mm
Max. Cable/Webbing 5.1mm x 10mtr 5.1mm x 10mtr 50mm x 7mtr 5.1mm x 10mtr 5.1mm x 10mtr 50mm x 10mtr
Size (Ø x L): (Not Included)		 (Not Included)		
Handle Length: 230mm 230mm 230mm 230mm 230mm 230mm
Unit weight: 2.6kg 2.1kg 2.6kg 3kg 2.5kg 3kg

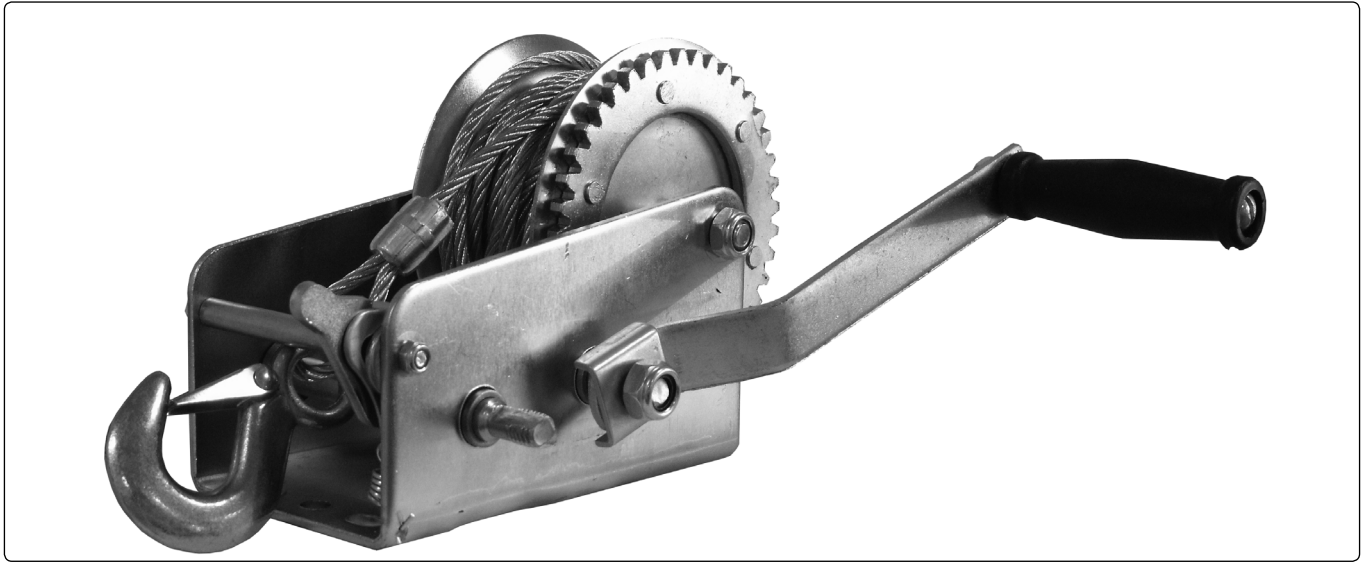

3. INSTALLATION

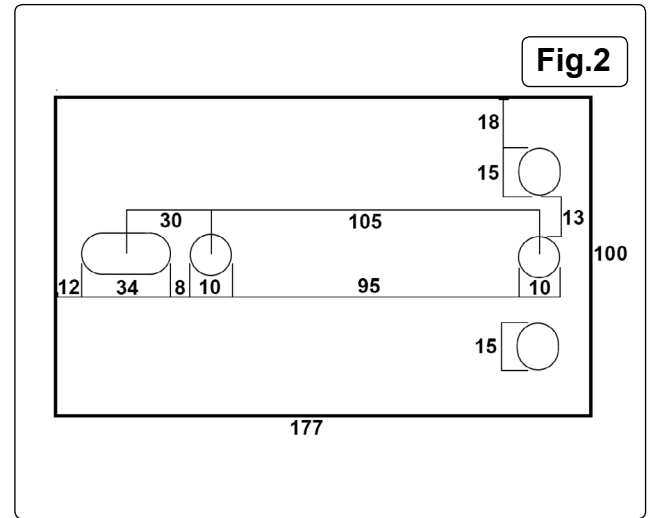
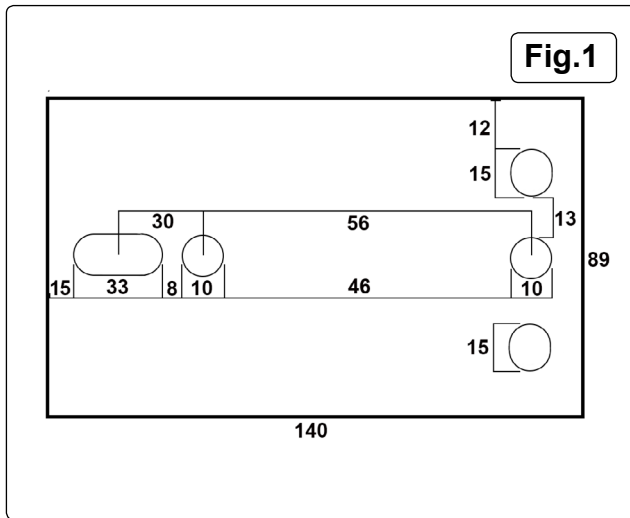

3.1. INSTALLING WINCH.

Most truck beds are not designed to support the pulling capacity of a winch. Choose an appropriately strong winching point, which when fitted will give the winch handle enough clearance to turn. We recommend that the fixing point is reinforced with steel plate. Ensure the fixing bolts are adequate for securing the winch with a full load. The winch mounting point must be capable of withstanding 4 x the maximum rated capacity of the winch.

For fixing dimensions see Fig.1. for GWC1200M, GWE1200M and GWW1200M and Fig.2. for GWC2000M, GWE2000M and GWW2000M.

3.2. CONNECTING THE CABLE.

3.2.1. Insert the steel cable through the hole (see fig.3) from inside to outside.

3.2.2. Thread the cable out and in the four holes, back through the original hole and through one more. Ensure the end is inside and not outside the drum.

3.3. CONNECTING THE STRAP.

3.3.1. The winch is designed to fit a strap as well as a cable. Push the Strap Fitting Bolt, through the belt loop in the direction of the arrow in fig.4.

3.3.2. Secure the Strap Fitting Bolt, with a spring washer and nut.

WARNING! The strap breaking strain must be at least 3 times the pulling capacity.

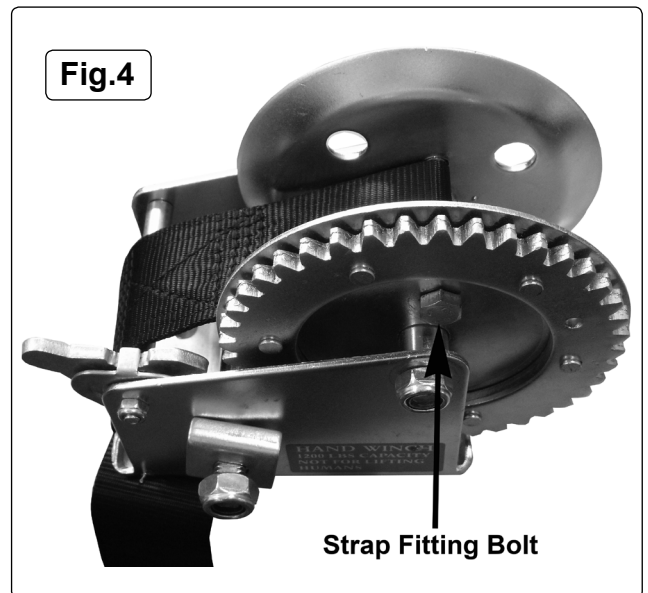
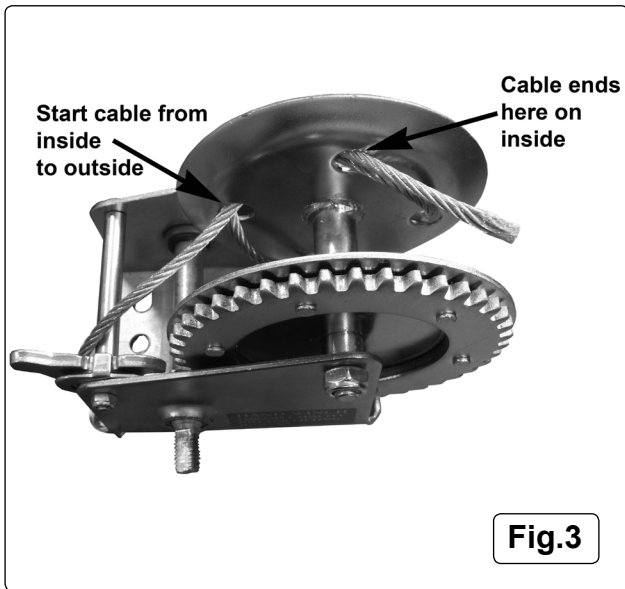

4. OPERATING INSTRUCTIONS

4.1. Instructions for Models: GWC1200M, GWE1200M and GWW1200M.

WARNING! Before using the winch ensure you read, understand and apply Section 1 safety instructions.

Note! Re-lubricate all shafts and gears before use.

- 4.1.1. Fit handle and secure with lock nut and supplied washer.
- 4.1.2. To lift, push direction selector into position shown in fig.5 and turn handle clockwise.
- 4.1.3. To lower, move the direction selector to the position shown in fig.6 and turn the handle anticlockwise.
- 4.1.4. To activate the free spool function, move the direction selector to the middle position, see fig.7.

4.2 Instructions for Models: GWC2000M, GWE2000M and GWW2000M.

- 4.2.1. Fit handle to desired ratio shaft and secure with washer and lock nut.
- 4.2.2. Refer to fig.8 for lower and lift directions.
- 4.2.3. Free wheel is selected by putting the direction selector in the middle position.

- WARNING!** Beware of injury caused by the spinning handle in free spool mode.
- WARNING!** Never fully extend the cable or strap when under load.
- WARNING!** Load capacity is reduced as layers build up on the drum.

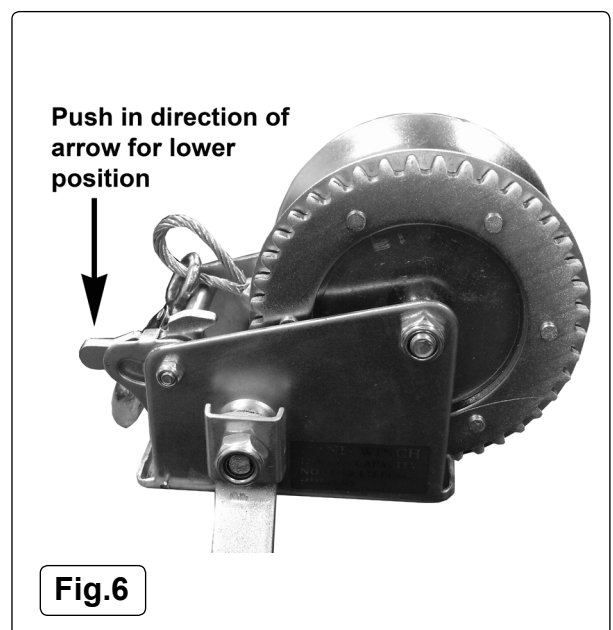
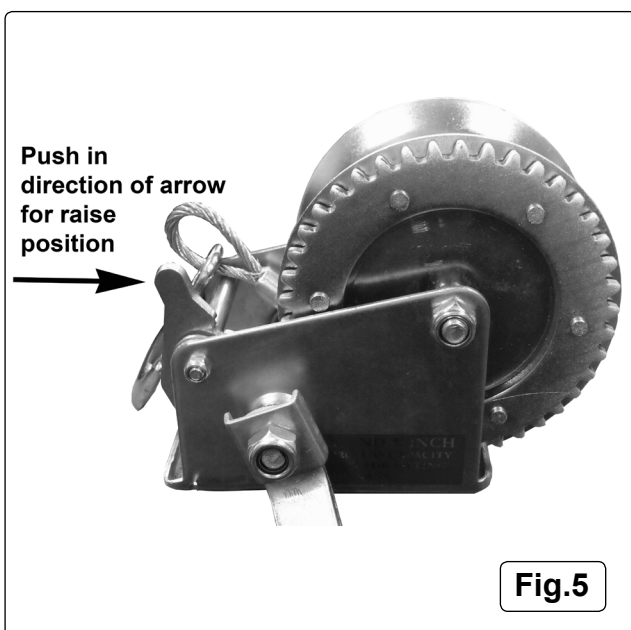

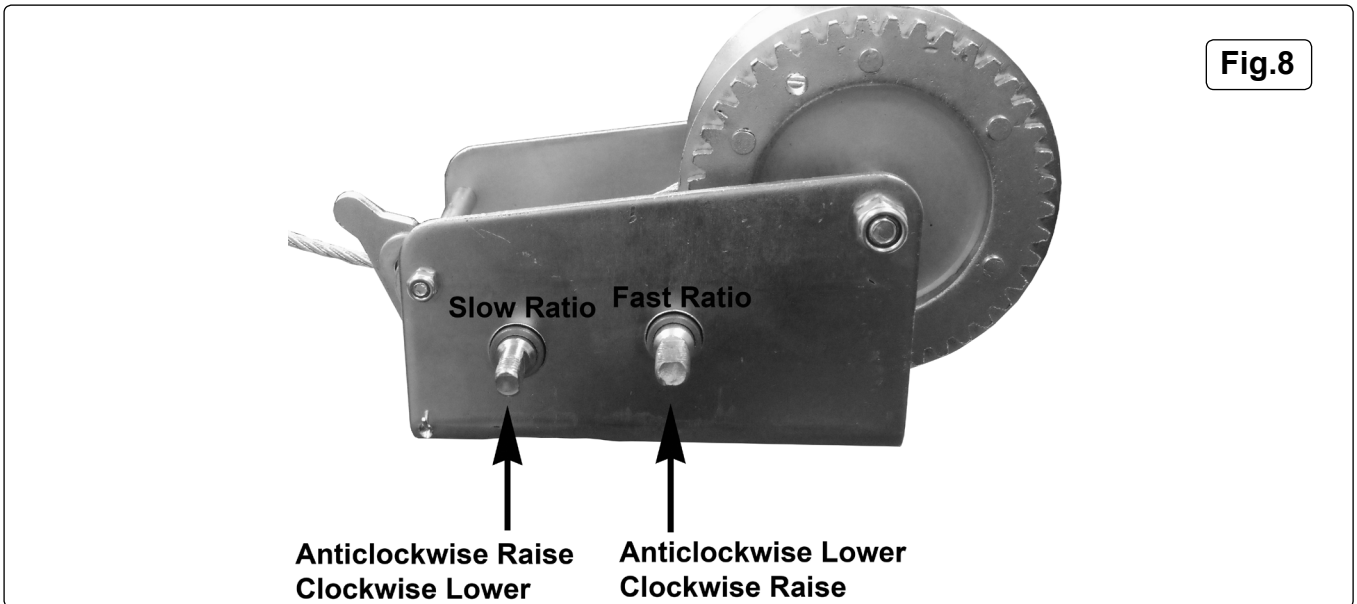
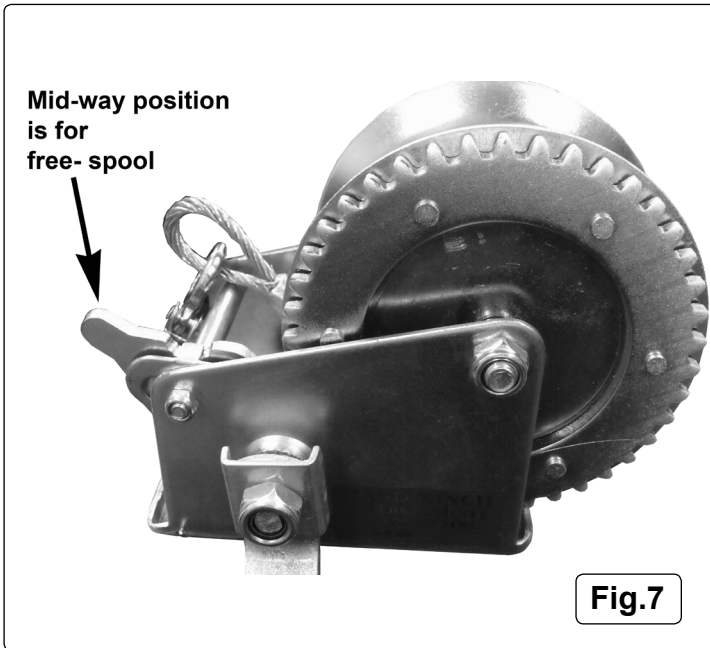

5. MAINTENANCE





Keep winch, cable and strap clean. Inspect cable and strap regularly checking for fraying, kinks, broken strands or distortion and replace if necessary. Keep the cable and unit lightly oiled for protection. Although the winch has been fully lubricated during manufacture, periodically grease gears, reel shaft and handle threads, **but DO NOT get oil or grease on the brake mechanism.**

Parts support is available for this product. To obtain a parts listing and/or diagram, please log on to: www.sealey.co.uk, email: sales@sealey.co.uk or phone: 01284 757500



Environmental Protection.
Recycle unwanted materials instead of disposing of them as waste. All tools, accessories and packaging should be sorted, taken to a recycle centre and disposed of in a manner which is compatible with the environment.

NOTE: It is our policy to continually improve products and as such we reserve the right to alter data, specifications and component parts without prior notice.
IMPORTANT: No liability is accepted for incorrect use of this product.
WARRANTY: Guarantee is 12 months from purchase date, proof of which will be required for any claim.
INFORMATION: For a copy of our latest catalogue and promotions call us on 01284 757525 and leave your full name and address, including postcode.

	Sole UK Distributor, Sealey Group, Kempson Way, Suffolk Business Park, Bury St. Edmunds, Suffolk, IP32 7AR	 01284 757500	 www.sealey.co.uk
		 01284 703534	 sales@sealey.co.uk